



PIKO

2024-2025
Catalog





Dear PIKO G-Scale Friends:

Along with some great new products, 2023 brought a special event—the opening of the Flagship Store at the worldwide PIKO headquarters in Sonneberg, Germany. Here, the vast PIKO product line in all scales is presented in an attractive atmosphere. If you are “in the neighborhood,” stop in for a wonderful shopping experience. It’s always worth a visit.

In 2024, there will be another very special event. Not only will we have our bi-annual Open House Day (Tag der Offenen Tür) at the factory in Sonneberg on Saturday, June 22nd, but at the same time, with many thousands of PIKO fans gathered, we will celebrate the 75th anniversary of PIKO. In addition to several specially decorated models that will be available for purchase, an updated chronicle will be published, covering the history of PIKO from the pioneering days to the present.

G-Scale enthusiasts will see yet another nice new German steam loco from PIKO, the legendary Prussian T 9.3 class, which later became the BR 91.3 series. This compact 2-6-0T tank loco is ideal for many types of vintage short trains, whether freight, passenger or mixed train service. Near the opposite end of the time spectrum, the new German IC control car is ready for the most up-to-date passenger service on your G-Scale layout.

With the much-loved round-nosed NoHAB diesel having just arrived, a unique version of that loco will replicate the real thing operated by Altmark-Rail in a beautiful winter-themed paint scheme.

Fans of American trains will also see many new items, from a new UP starter set to a variety of Mogul locos, to more of our 25-Ton diesel locos factory-equipped with R/C and sound for battery

operation. New passenger and freight cars in a variety of roadnames and styles will round out the new items selection. But that won't be everything new for the year. We will leave you guessing a bit longer about the list of Autumn surprises and creative new Christmas items.







As always, whether your interest is PIKO G-Scale, or HO-, N- or even TT-Scale, we are glad to hear from you. Suggestions have helped us develop and produce countless new products. And we enjoy talking to the many fine folks we've met over the years. Stay tuned to the latest news at www.piko-america.com and even more news at the factory website www.piko.de. On behalf of hundreds of PIKO workers around the world, we wish you - as they say in Germany - Viel Spaß! Lots of fun with your PIKO trains!

Ortrun D. Wilfer

Andrea Wilfer

Dr. René F. Wilfer



STARTER SETS	
PIKO G-TRACK	
LOCOMOTIVES	
CARS	
PIKO R/C, PIKO-DIGITAL	
ACCESSORIES	
MODEL BUILDINGS	

STARTER-SETS 9

PIKO G-TRACK 19

Geometry 20
 System 20
 Straight tracks 24
 Curved tracks..... 25
 Switches..... 26
 Accessories 29
 Track sets 32

LOCOMOTIVES 35

American Diesel Locos 36
 American Steam Locos 38
 European Steam Locos 44
 European Electric Locos 52
 European Diesel Locos..... 58
 Railbuses 65

CARS 65

American Passenger Cars 68
 European Passenger Cars 75
 American Freight Cars 84
 European Freight Cars 99

PIKO POWER & ACCESSORIES 107

PIKO R/C..... 108
 PIKO Analog DC Power..... 111
 PIKO Digital-System..... 112
 PIKO SmartProgrammer & Tester..... 114
 PIKO SmartDecoder 115
 Sound..... 116

























ACCESSORIES 117

Service Parts 117
 Lighting and Gearboxes 120
 Maintenance and Track Cleaning..... 121

MODEL BUILDINGS 123

Building Kits 124
 Pleasantown Building Kits 170
 Built-Ups 172
 Christmas Buildings 177
 Pleasantown Christmas Kits..... 179
 Accessories 180
 Index 185

Signs & Symbols

-   Direct current
-  DC/DCC Decoder-Equipped
-  Digital decoder-ready
-  Length over buffers
-  Weight
-  4 kg
-  Directional Lights
-  Directional lights white/red
-  Directional Lights LEDs
-  Directional lights white/red LEDs
-  Directional lights red/red LEDs
-  Interior Lighting-ready
-  Interior Lighting
-  Running gear lights
-  Number of motors
-  2x
-  Ball bearing motor
-  Smoke Unit - ready
-  Smoke Unit-Equipped
-  Number of traction tires
-  600 Minimum radius
-  Hard-chromed wheels
-  Ball bearing, hard-chromed wheels

 Metal wheel sets available for cars

 Sound-ready

 Sound-Equipped

 Radio Control

 incl. PSD XP

 incl. PSD XP Sound

 Limited Availability (while stock lasts)

Railways

- B, SNCB** Belgian State Railway
- CFL** Luxembourg State Railway
- DB** German Federal Railway
- DB AG** German Federal Railway Inc.
- DR** German Imperial Railway,
- NS** Dutch State Railway
- ÖBB** Austrian Federal Railway
- PKP®** Polish State Railway
- RENFE** Spanish State Railway
- SBB** Swiss Federal Railway

SNCF® and PKP® are registered Trademarks. All rights reserved.

Disclaimer:

While every effort has been made to ensure the accuracy of information in this catalog, PIKO America LLC and PIKO Spielwaren GmbH assume no responsibility for any errors. Products, specifications, technical details and availability subject to change without notice.

Private Railways

- CFL Cargo** Luxemburgisches, internationales Unternehmen
- C&S** Colorado & Southern
- CTL Cargo** Trans Logistik AG
- EGP** Eisenbahngesellschaft Potsdam
- HSB** Harzer Schmalspurbahnen
- MRCE** Mitsui Rail Capital Europe B.V.
- MWB** Mittelweserbahn
- On Rail** Private Wagon-Vermietgesellschaft Mettmann
- PEG** Prignitzer Eisenbahn GmbH
- B&O** Baltimore & Ohio
- CN** Canadian National
- D&RGW** Denver & Rio Grande Western*
- NYC** New York Central
- RDG** Reading Lines
- PRR** Pennsylvania Railroad
- SF** Santa Fe
- SP** Southern Pacific*
- UP** Union Pacific Railroad Company*
- WP&YR** White Pass & Yukon Route
- WP** Western Pacific*

*Produced under trademark license from Union Pacific Railroad Company.

Periods

- I** **Period I 1835 – 1925**
First railways were built and numerous state and private railways founded.
- II** **Period II 1925 – 1945**
Founding of large state railway companies such as DRG, BBÖ or SBB. Regulations were synchronised and standards of construction established. First electric operation.
- III** **Period III 1945 – 1970**
Reconstruction and recovery from war damage to the railways. Steam locos began to be replaced by diesel and electric locos. Construction of passenger coaches and goods trucks in cooperation with other state railways.
- IV** **Period IV 1970 – 1990**
End of steam operation. Introduction of computer-oriented classifications on locos and other vehicles. Pre-war equipment taken out of service.
- V** **Period V 1990 – 2007**
Beginning of the ICE age. Fusion of DB and DR. Introduction of "traffic red". Reorganisation of the railway into business divisions. Modern locos and motor coaches taken into service.
- VI** **Period VI 2007 – today**
Besides traditional railroad companies, many private railroad transit companies also travel existing railroad networks in national and international transport with their own vehicles. Introducing the 12-digit UIC numbering system.



QUALITY HIGHLIGHTS



Many models with ball bearings on driven axles and hard-chrome plated wheels for improved power pickup

Locomotives with enclosed gearboxes, precision "can" type motors and reliable gear drive for smooth, long-lasting performance

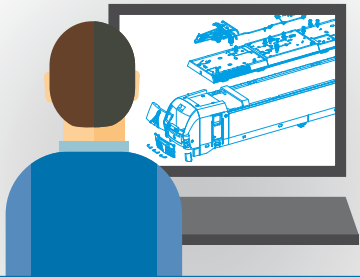

Design

Model design according to the dimensions and engineering drawings of the original.



Moldshop

Highly skilled machinists combine computer-aided milling with painstaking hand work to make hardened steel molds for plastic injection.

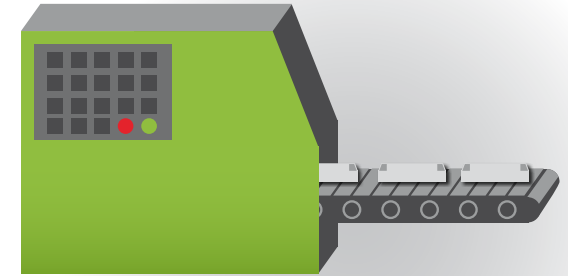

Plastic Injection

The high level of detail in today's plastic parts was unthinkable just a few years ago.



Logistics

Packing and delivery of locos and cars, tracks and buildings to retailers and customers all over the world.

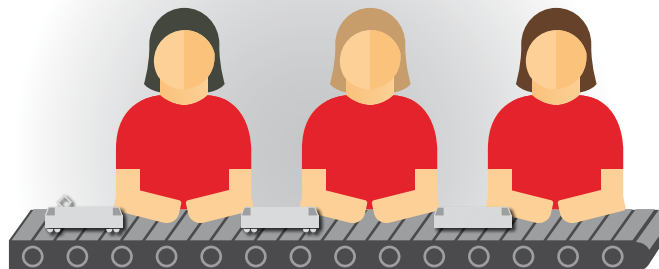

Assembly

Assembly involves fitting many delicate detail parts and multiple quality control checks.

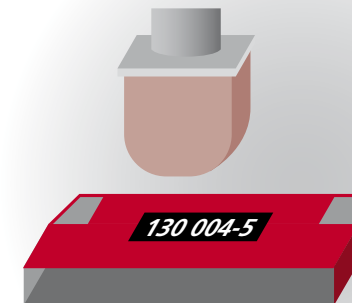

Printing

Giving a model colorful and accurate decorations often takes over 40 painting and printing steps.

STARTER SETS



STARTER SETS

- > Robust technology
- > Excellent operating characteristics
- > High degree of realism
 - > Weather-resistant materials for indoor/outdoor use
 - > Everything needed is included – Locomotive, cars, track, power supply and more



See this and more great starter sets on the following pages.



38107 PRR Freight R/C Starter Set

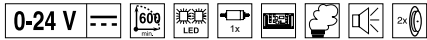

Contents 38107/38108:

- 1 x Steam Loco
- 2 x Freight Cars
- 12 x 35211 R1 (Curve Track R1 600 mm / 23.6")
- 1 x 35270 Track Power Clamp
- 1 x 35285 Track Clips, 14 pcs.
- 1 x R/C Pocket Remote
- 1 x R/C Track Power Controller
- 1 x Safety-Approved 120 V Transformer 24 V DC / 45 VA

Sets 38107, 38108 and 38109 include:

These starter sets feature a simple R/C track power controller and pocket remote for easy wireless walk-around control of train speed and direction, as well as accessory power and emergency stop. This R/C Track Power Controller can also operate other locos, with no loco modification. (Not applicable to set 38113.)



38108 SF Freight R/C Starter Set

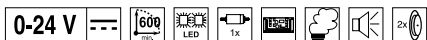



38109 White Pass & Yukon Freight R/C Starter Set with Smoke and Sound



For all Starter Sets:

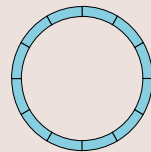

Floor area: \varnothing 51.18"
Minimum area for assembly: \varnothing 59.06"

Contents 38109:

- | | |
|---|---------------------------------------|
| 1 x Steam Loco | 1 x R/C Track Power Controller |
| 2 x Freight Cars | 1 x Safety-Approved 120 V Transformer |
| 12 x 35211 R1 (Curve Track R1 600 mm / 23.6") | 24 V DC / 45 VA |
| 1 x 35270 Track Power Clamp | 1 x 36039 Uncoupling Wand |
| 1 x 35285 Track Clips, 14 pcs. | 1 x Smoke Fluid (10 ml) |
| 1 x R/C Pocket Remote | |

**NEW
2024**



38113 UP Freight Starter Set



Contents 38113:

- | | |
|---|---------------------------------------|
| 1 x Steam Loco | 1 x 35285 Track Clips, 14 pcs. |
| 2 x Freight Cars | 1 x Analog Throttle |
| 12 x 35211 R1 (Curve Track R1 600 mm / 23.6") | 1 x Safety-Approved 120 V Transformer |
| 1 x 35270 Track Power Clamp | 24 V DC / 45 VA |



38152 North Pole Hauler R/C Starter Set



Contents 38152/38153:

- 1 x 25 Ton Diesel Loco
- 2 x Freight Cars
- 1 x R/C Track Power Controller
- 1 x Safety-Approved 120 V Transformer
24 V DC / 45 VA
- 12 x 35211 R1 (Curve Track R1 600 mm / 23.6")
- 1 x 35270 Track Power Clamp
- 1 x 35285 Track Clips, 14 pcs.
- 1 x R/C Pocket Remote

The 37155 Building Block Starter Set is completely battery-powered and includes a pocket remote for easy wireless walk-around control of train speed, direction and emergency stop. 6x 'AAA' batteries (not included, high-capacity rechargeables are recommended) give up to two hours run time. The front of the engine hood opens up for easy access to the quick-change battery clip inside.



(Building blocks not included)



37155 Building Block Battery R/C Starter Set

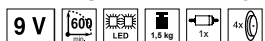

Contents 37155:

- 1 x 25 Ton Diesel Loco
- 2 x Building Block Flatcars
- 12 x 35211 R1 (Curve Track R1 600 mm / 23.6")
- 14 x 35285 Track Clips
- 1 x R/C Pocket Remote



38112 D&RGW Passenger R/C Starter Set with 2 Passenger Cars, Smoke and Analog Sound

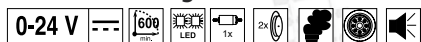

Sets 38112, 38123 and 38152 include:

These starter sets feature a simple R/C track power controller and pocket remote for easy wireless walk-around control of train speed and direction, as well as accessory power and emergency stop. This R/C Track Power Controller can also operate other locos, with no loco modification.

Contents 38112/38123:

- | | |
|---|--|
| 1 x Steam Loco with Smoke & Analog Sound | 1 x R/C Pocket Remote |
| 2 x Passenger Cars (only for 38112) | 1 x Safety-Approved 120 V Transformer
24 V DC / 45 VA |
| 3 x Freight Cars (only for 38123) | 1 x 36039 Uncoupling Wand |
| 12 x 35211 R1 (Curve Track R1 600 mm / 23.6") | 1 x Smoke Fluid (10 ml) |
| 1 x 35270 Track Power Clamp | 2 x 35268 Track Magnets |
| 1 x 35285 Track Clips, 14 pcs. | |
| 1 x R/C Track Power Controller | |



38123 Christmas Freight R/C Starter Set with 3 Freight Cars, Smoke and Analog Sound

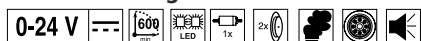



Developed in exclusive cooperation with Circus Roncalli



37154 Circus Roncalli Battery R/C Starter Set



The 37154 Circus Roncalli Starter Set is completely battery-powered and includes a pocket remote for easy wireless walk-around control of train speed, direction and emergency stop. 6x 'AAA' batteries (not included, high-capacity rechargeables are recommended) give up to two hours run time. The front of the engine hood opens up for easy access to the quick-change battery clip inside.

Contents 37154:

- 1 x 25 Ton Diesel Loco
- 2 x Freight/Passenger Cars
- 12 x 35211 R1 (Curve Track R1 600 mm / 23.6")
- 14 x 35285 Track Clips
- 1 x R/C Pocket Remote



37100 DB III BR 80 Ore Starter Set



Contents 37100:

- 1 x Steam Loco
- 2 x Freight Cars
- 12 x 35211 R1 (Curve Track R1 600 mm / 23.6")
- 1 x 35270 Track Power Clamp
- 14 x 35285 Track Clips
- 1 x Analog Throttle
- 1 x Safety-Approved 120 V Transformer 24 V DC / 45 VA



37130 Classic BR 80 Steam Passenger Starter Set



Contents 38130:

- 1 x Steam Loco
- 2 x Passenger Cars
- 12 x 35211 R1 (Curve Track R1 600 mm / 23.6")
- 1 x 35270 Track Power Clamp

- 14 x 35285 Track Clips
- 1 x Analog Throttle
- 1 x Safety-Approved 120 V Transformer 24 V DC / 45 VA
- 1 x 36039 Uncoupling Wand



For all Starter Sets:

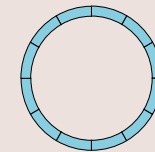

Floor area: Ø 51.18"
Minimum area for assembly: Ø 59.06"



37151 Industrial Starter Set



Contents 38151:

- 1 x 25 Ton Diesel Loco
- 2 x Freight Cars
- 12 x 35211 R1 (Curve Track R1 600 mm / 23.6")
- 1 x 35270 Track Power Clamp

- 14 x 35285 Track Clips
- 1 x Analog Throttle
- 1 x Safety-Approved 120 V Transformer 24 V DC / 45 VA

STARTER SETS

STARTER SETS

These PIKO G-Starter Sets come complete with everything required to enter into the world of G-Scale railroading: a powerful locomotive, cars, a full circle of brass track, power hookups, throttle and safety-approved transformer. It's easy to just open the package, assemble the set (no tools needed!) and start running trains.

PIKO G trains and accessories are built of incredibly tough weather-resistant materials for years of enjoyment indoors or out.

**NEW
2024**



37145 DR III V100 R/C Passenger Starter Set



Contents 37145:

- 1 x Diesel Loco
- 2 x Passenger Cars
- 1 x R/C Track Power Controller
- 1 x Safety-Approved 120 V Transformer 24 V DC / 45 VA

- 12 x 35211 R1 (Curve Track R1 600 mm / 23.6")
- 1 x 35270 Track Power Clamp
- 1 x 35285 Track Clips, 14 pcs.
- 1 x R/C Pocket Remote



37126 DR III V20 Freight Starter Set with Analog Sound



Contents 38121:

- 1 x Model car Trabant



37121 DB III V20 Passenger Starter Set with Analog Sound



For all Starter Sets:

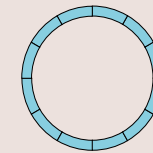

Floor area: \varnothing 51.18"
Minimum area for assembly: \varnothing 59.06"



37120 DB III BR 80 Freight Starter Set with Smoke and Analog Sound



Contents 38120:
1 x Smoke Fluid (10 ml)



37125 DR III BR 80 Passenger Starter Set with Smoke and Analog Sound

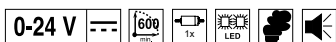

Contents 38125:
1 x Smoke Fluid (10 ml)

- Contents 38120, 38121, 38125, 38126:
- 1 x Diesel Loco/Steam Loco
 - 2 x Freight/Passenger Cars
 - 12 x 35211 R1 (Curve Track R1 600 mm / 23.6")
 - 1 x 35270 Track Power Clamp
 - 14 x 35285 Track Clips
 - 1 x Safety-Approved 120 V Transformer
24 V DC / 45 VA
 - 1 x Analog Throttle
 - 2 x 35268 Track Magnets
 - 1 x 36039 Uncoupling Wand



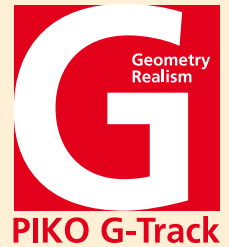

PIKO G-TRACK

- > Code 332 (0.332" high) solid rails of pure, virgin brass for excellent electrical conductivity.
- > Unique track geometry makes even complex track plans simple to build with only a few different types of track sections.
- > Unlimited possibilities due to full compatibility with track from other brands, like LGB** and others.

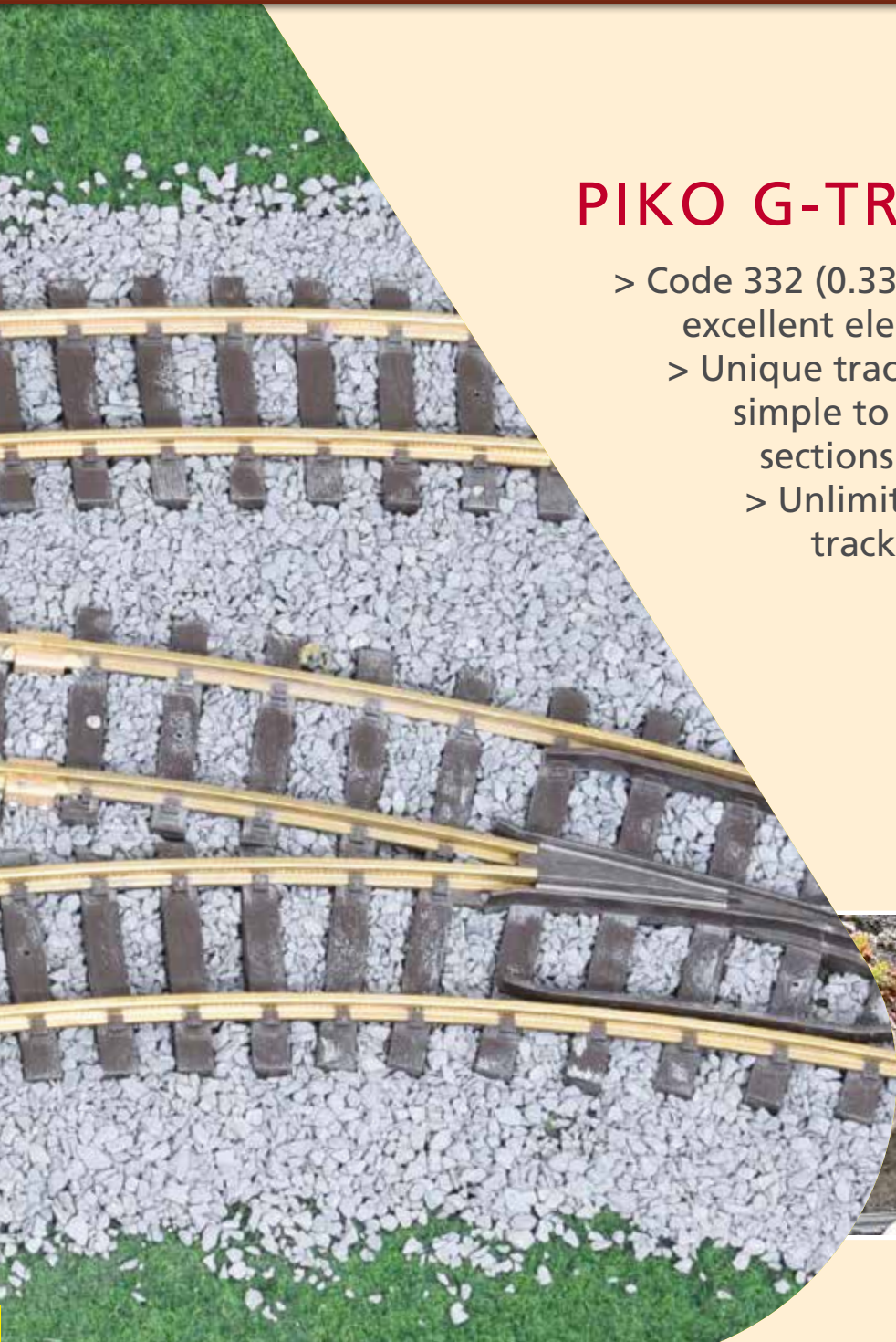

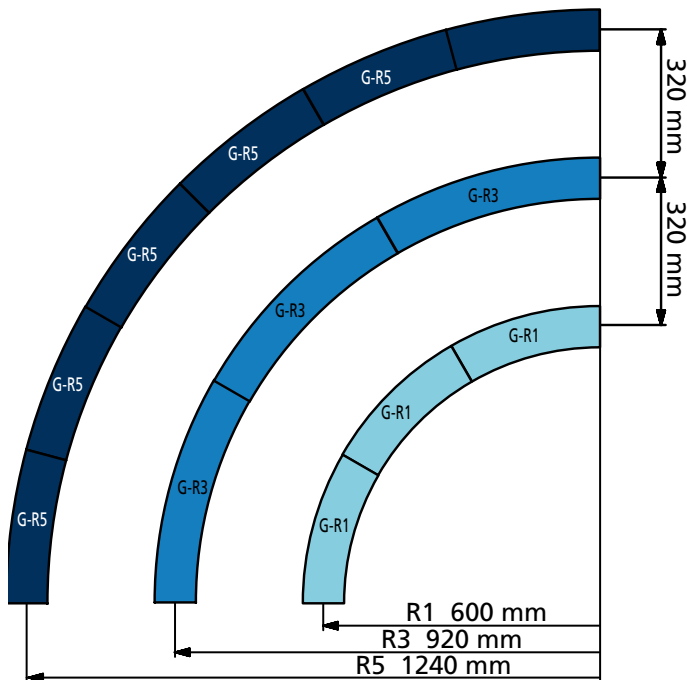
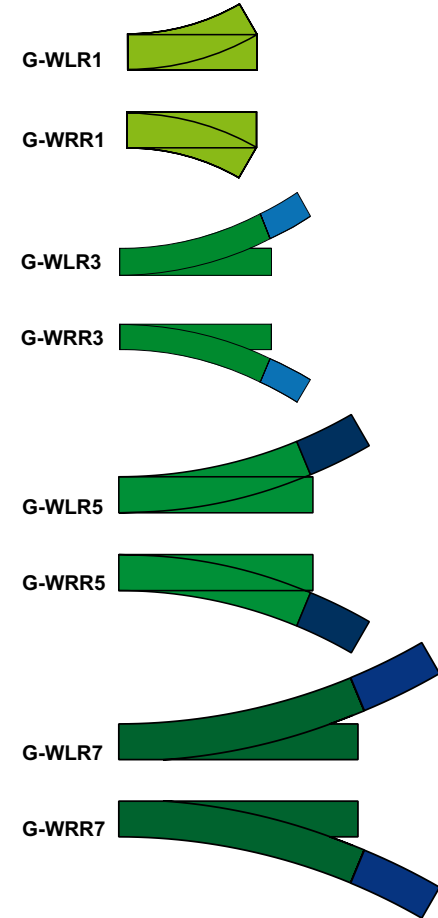
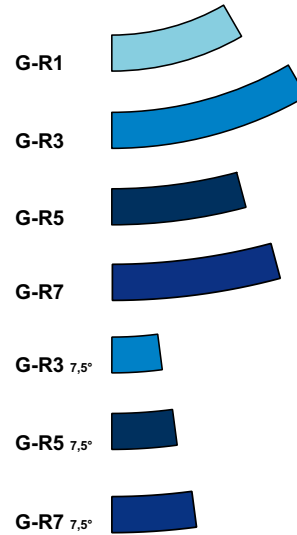
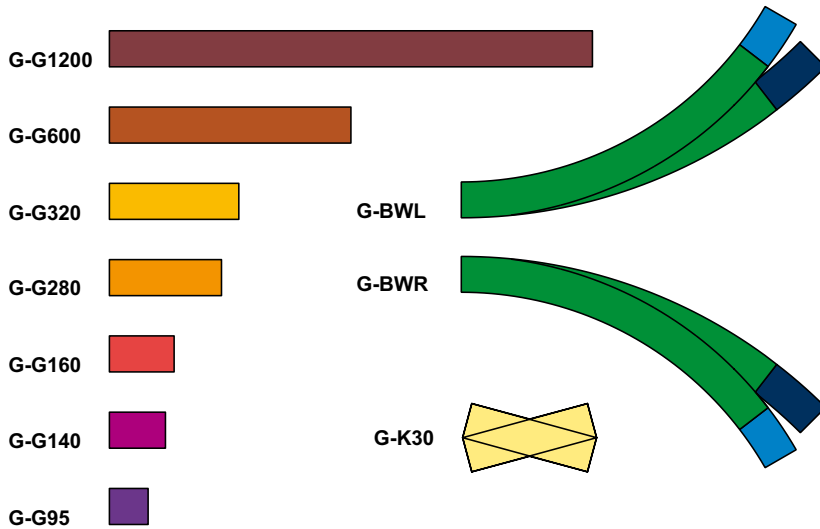

- 35200 G-G320 Straight Track, 12.66" (320 mm)
- 35201 G-G280 Straight Track, 10.96" (280 mm)
- 35202 G-G160 Straight Track, 160 mm (6.30")
- 35203 G-G140 Straight Track, 140 mm (5.48")
- 35204 G-G95 Straight Track, 95 mm (3.74")
- 35209 G-G1200 Straight Track, 47.24" (1200 mm)
- 35208 G-G600 Straight Track, 23.62" (600 mm)
- 35211 G-R1 Curved track 30°, r = 23.62" (600 mm)
- 35213 G-R3 Curved track 30°, r = 920 mm (36.28")
- 35215 G-R5 Curved track 15°, r = 1240 mm (48.94")
- 32516 G-R5 7,5° Curved track 7,5°, r = 1200 mm (48.82")
- 35218 G-R7 7,5° Curved track 7,5°, r = 1565 mm (61.60")

- 35240 G-K30 Crossing, 30°
- 35220 G-WLR1 Manual Switch, Left, R1, 30°
- 35221 G-WRR1 Manual Switch, Right, R1, 30°
- 35228 G-WLR3 Manual Switch, Left, R3, 22,5°
- 35229 G-WRR3 Manual Switch, Right, R3, 22,5°
- 35222 G-WLR5 Manual Switch, Left, R5, 22,5°
- 35223 G-WRR5 Manual Switch, Right, R5, 22,5°
- 35226 G-WLR7 Manual Switch, Left, R7, 22,5°
- 35227 G-WRR7 Manual Switch, Right, R7, 22,5°
- 35224 G-BWL Manual Curved Switch, Left
- 35225 G-BWR Manual Curved Switch, Right

The 23.62" Grid – The Starting Point

The PIKO G-Track design is based on a 23.62" x 6.30" (600 x 160 mm) grid. These dimensions were not chosen at random. They are the result of extensive computer-aided engineering with the goal to satisfy the requirements of beginners and advanced hobbyists alike.

With this grid, almost all track designs can be realized without the need for short adapter pieces. This includes elegant turnouts on the straight or on curves, as well as parallel tracks at various distances that allow the use of existing accessories, such as platforms.

The simple grid system eliminates the need for complicated design charts. Instead layouts can be designed on ordinary graph paper to determine the track elements required.

The Track Design. The outstanding feature of PIKO G-Track's design is that it only requires a small set of different track elements. Neither switches nor crossovers require the installation of short adapter pieces, which often cause uneven running and electrical contact problems.

For straight track the grid's base length of 23.62" (600 mm) is partitioned into two sections that are 12.66" (320 mm) and 10.96" (280 mm) in length. This makes it possible to have parallel tracks connected by two turnouts without any extra adapter pieces.

The Track PIKO G-Track rails are made from high quality, pure, virgin brass. The ample cross-section of solid Code 332 rail allows for optimal conductivity with minimal voltage loss, even over long distances. The brass rail joiners create a secure and durable connection between sections and ensure good electrical contact at the joints.

The ties are made of ultra-violet stabilized HDPE plastic, which is characterized by its high impact resistance, noise reduction properties and resistance to cracking under stress.

Track Identification In addition to the item number, the PIKO G-Track system uses track element names such as G-G320. These names identify the elements in the various track diagrams. In addition to its name, each track section has an associated color that is used in track diagrams, brochures, catalogs, and on the boxes. This makes it easy to identify the desired piece of track.

Straight Track The PIKO G-Track system normally requires only two straight track sections: G-G320 and G-G280. When joined these two sections form the grid's 600 mm base length. The other straight track sections, such as G-G160 and G-G140, can be used anywhere but are only necessary when creating more complex track layouts.

Flex track For construction of smooth flowing curves with any desired radius, the PIKO G-Track system also includes flex track. It is assembled from individual rails and tie strips. Using the G-SB280 and G-SB320 tie strips with the G-P1500 or G-P3000 rail sections, you can build your own flex track.

Please note: A rail bending tool is required to accurately bend the flex track to a desired radius, but long straight tracks can be easily built without tools.

The Curves The PIKO G-Track offers 4 basic radii that are spaced 320 mm apart.

G-R1 curved track 30°, r = 23.62" (600 mm)

G-R3 curved track 30°, r = 36.28" (921.54 mm)

G-R5 curved track 15°, r = 48.94" (1,243.08 mm)

G-R7 curved track 15°, r = 61.60" (1,564.62 mm)

To form a complete circle (360°), 12 curved track sections are required for the radii G-R1 and G-R3 and 24 for the radii G-R5 and G-R7. The 12.66" (320 mm) distance between tracks ensures that even on radius G-R1 and G-R3 long rolling stock can pass without interference.

Curved Track for Switches To get from a switch to a parallel track (such as on a passing siding) while maintaining the grid's base distance of 6.34" (160 mm), a single G-R1 curved track section is required.

Switches All PIKO G-Track switches can be operated as manual or electric switches. By attaching an electric switch machine, any switch easily converts to electrical operation.

Details The finely reproduced spike and bolt, which secure the rail to the tie in the original, are designed so that standard compliant wheel sets run smoothly over all elements of the PIKO G-Track.

Laying Track The sturdy, high quality, brass rail joiners ensure that PIKO G-Track can be laid on almost any surface, even indoor carpet or across a lawn in the garden.

Power Hook-up The easiest way to hook up power to the PIKO G-Track is the Power Clamp (#35270). It can be attached to any track section.

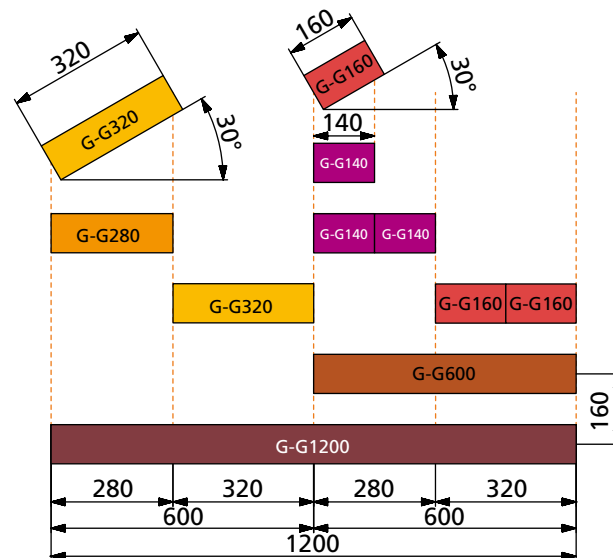

Straight Track

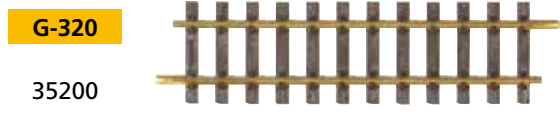

35200 Straight Track, 12.6" (320 mm)
Exact Length 12.66" (321.54 mm)
G-320 + G-280 make up the module length of 23.62" (600 mm)



35201 Straight Track, 11" (280 mm)
Exact Length 10.96" (278.46 mm)
G-280 + G-320 make up the module length of 23.62" (600 mm)

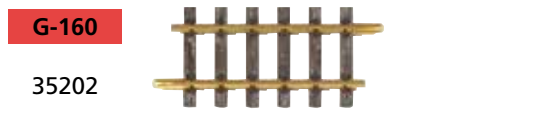

35202 Straight Track, 6.3" (160 mm)
Exact Length 6.33" (160.77 mm)
Half of the G-320 section length

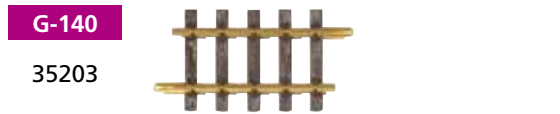

35203 Straight Track, 5.5" (140 mm)
Exact Length 5.48" (139.23 mm)
Half of the G-280 section length



35204 Straight Track, 3.75" (95 mm)
Exact Length 3.79" (96.15 mm)

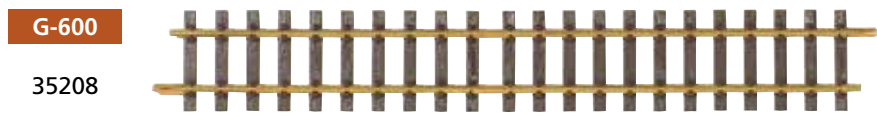

35208 Straight Track, 23.6" (600 mm)
Exact Length 23.62" (600 mm)
This is the standard PIKO G-Track module of 23.62" (600 mm)

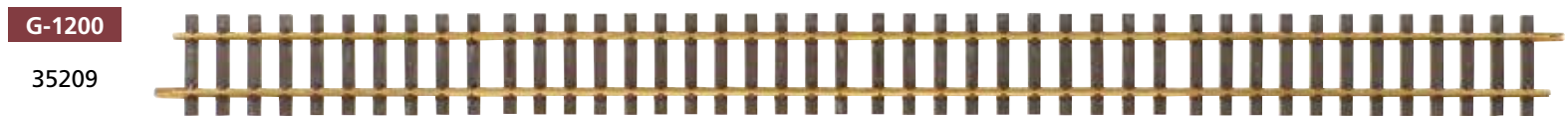

35209 Straight Track, 47.25" (1200 mm)
Exact Length 47.24" (1200 mm)
Double the standard G-Track module of 23.62" (600 mm)

CURVE TRACK SECTIONS

Curved Track

G-R1

35211

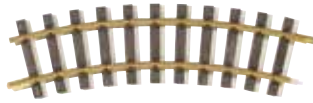

35211 Curve Track, R1 23.6" R (600 mm)
 Exact Center Line Radius = 23.62" (600 mm)
 30° per section / 12 sections per circle

G-R3

35213

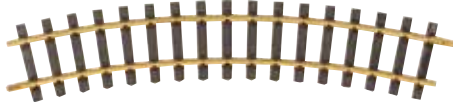

35213 Curve Track, R3 36.25" R (920 mm)
 Exact Center Line Radius = 36.28" (921.54 mm)
 30° per section / 12 sections per circle

G-R5

35215

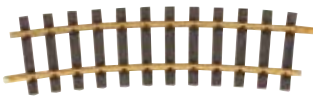

35215 Curve Track, R5 49" R (1240 mm)
 Exact Center Line Radius = 48.94" (1243.08 mm)
 15° per section / 24 sections per circle

G-R7

35217



35217 Curve Track, R7 61.6" R (1565 mm)
 Exact Center Line Radius = 61.6" (1564.6 mm)
 15° per section / 24 sections per circle

G-R3 7,5°

35214

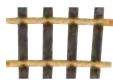

35214 Curve Track, R3 7.5° 36.25" R (920 mm)
 Exact Center Line Radius = 36.28" (921.54 mm)
 7.5° per section / 48 sections per circle

G-R5 7,5°

35216

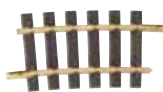

35216 Curve Track, R5 7.5° 47.25" R (1200 mm)
 Exact Center Line Radius = 47.24" (1200 mm)
 7.5° per section / 48 sections per circle

G-R7 7,5°

35218



35218 Curve Track, R7 7.5° 61.6" R (1565 mm)
 Exact Center Line Radius = 61.6" (1564.6 mm)
 7.5° per section / 48 sections per circle

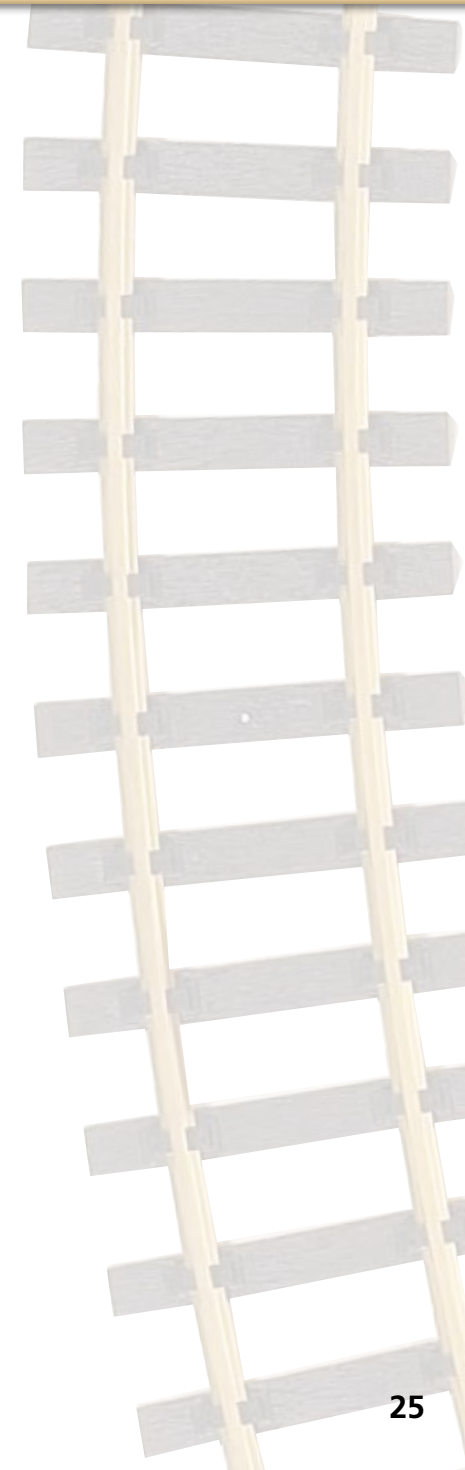

Switches and Crossing

G-WLR1

35220

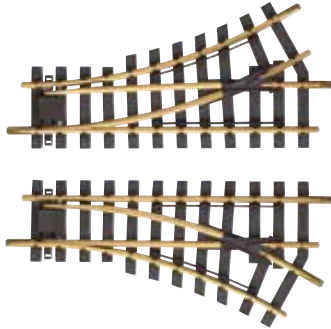

G-WRR1

35221

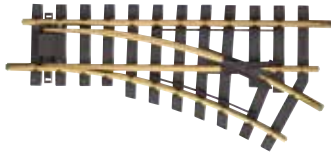

G-WLR5

35222

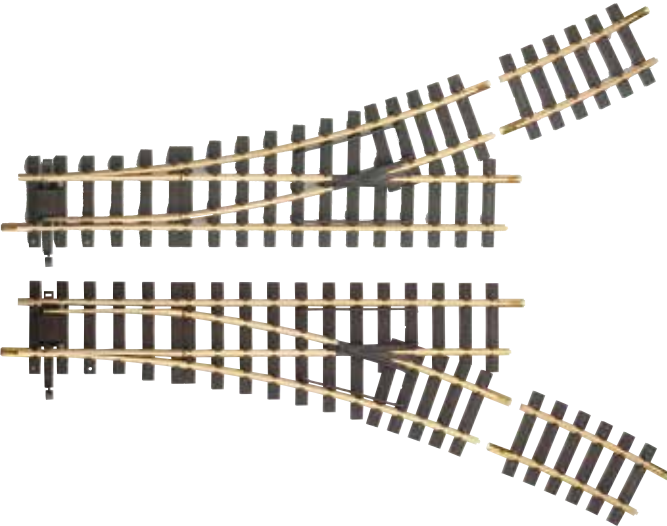

G-WRR5

35223

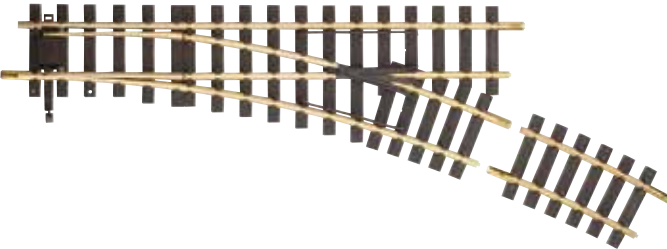

G-K30

35240

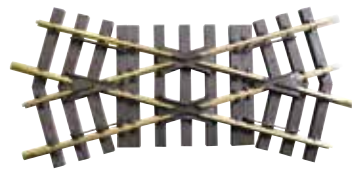

35220 Manual Switch, Left, R1, 30°

Straight track = G-320, 12.60" (320 mm)

Curved track = R1 = 23.62" (600 mm)

Compatible electric switch machine #35271

35221 Manual Switch, Right, R1, 30°

Straight track = G-G320, 12.60" (320 mm)

Curved track = R1 = 23.62" (600 mm)

Compatible electric switch machine #35271

35222 Manual Switch, Left, R5, 22.5°

Straight track = G-320 + G-160 = 18.90" (480 mm)

Curved track = 3 x Curve R5, 7.5°, 48.82" (1200 mm)

Package includes one Curve R5 7.5°

Compatible electric switch machine #35271

35223 Manual Switch, Right, R5, 22.5°

Straight track = G-320 + G-160 = 18.90" (480 mm)

Curved track = 3 x Curve R5, 7.5°, 48.82" (1200 mm)

Package includes one Curve R5 7.5°

Compatible electric switch machine #35271

35240 Crossing, 30°

Straight tracks = G320

G-WLR3
35228

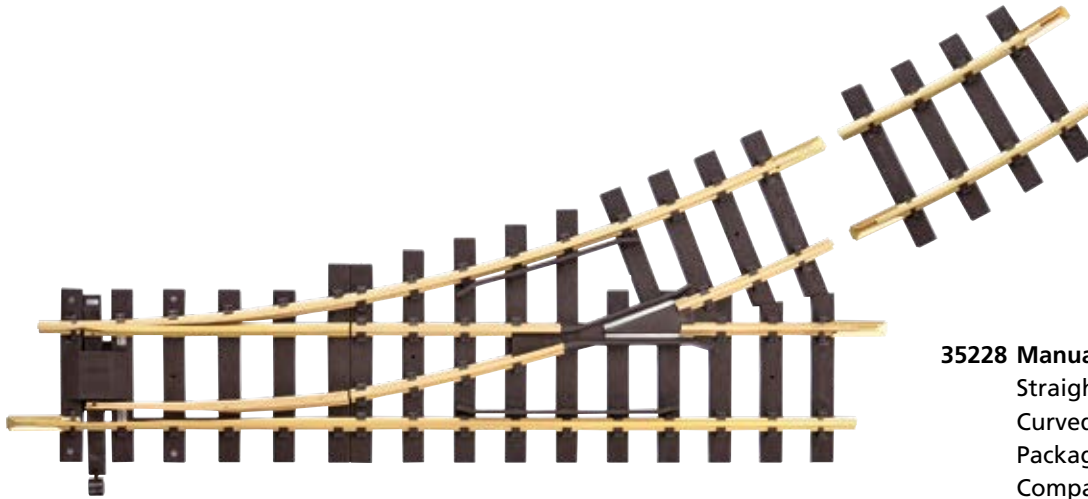

35228 Manual Switch, Left, R3, 22.5°

Straight track = $G280 + G140 = 16.44''$ (417.69 mm)

Curved track = $3 \times R3\ 7.5^\circ = 36.28''$ (921.54 mm)

Package includes one curve R3 7.5°

Compatible electric switch machine #35271

G-WRR3
35229

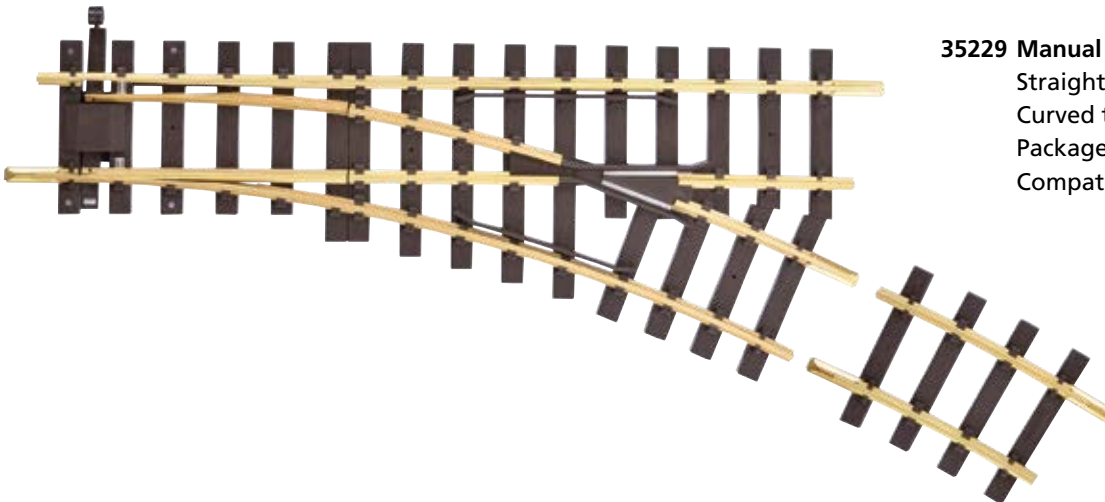

35229 Manual Switch, Right, R3, 22.5°

Straight track = $G280 + G140 = 16.44''$ (417.69 mm)

Curved track = $3 \times R3\ 7.5^\circ = 36.28''$ (921.54 mm)

Package includes one curve R3 7.5°

Compatible electric switch machine #35271

Larger Switches

G-WLR7

35226

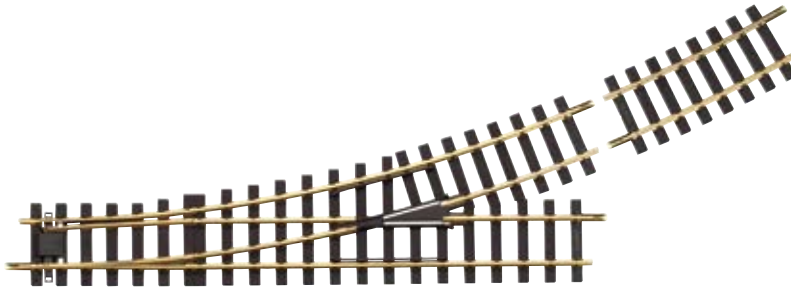

G-WRR7

35227

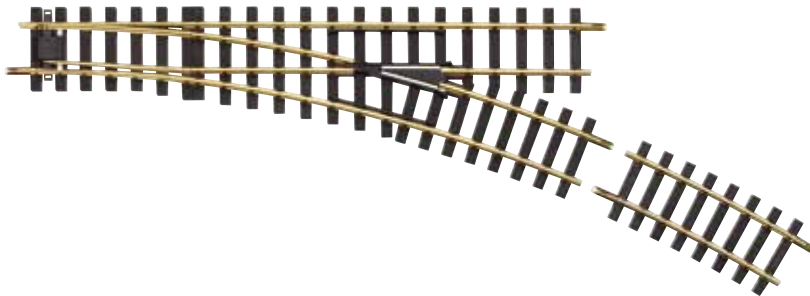

35226 Manual Switch, Left, R7, 22.5°

Curved track = 3 x Curve R7 7.5°, 61.60", 1564.62 mm

Straight track = G-600, 23.62", 600 mm

Package includes one Curve R7 7.5°

Compatible electric switch machine #35271

35227 Manual Switch, Right, R7, 22.5°

Curved track = 3 x Curve R7 7.5°, 61.60", 1564.62 mm

Straight track = G-600, 23.62", 600 mm

Package includes one Curve R7 7.5°

Compatible electric switch machine #35271

G-BWL

35224

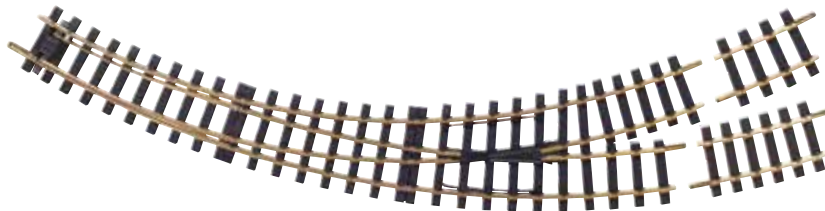

35224 Manual Curved Switch, Left R3-R5

Inner Curve = Curve R3, 52.5°

Radius 36.26", 921 mm

Outer Curve = Curve R5, 37.5°

Radius 47.24", 1200 mm

Package includes R3 7.5° and R5 7.5°

Compatible electric switch machine #35271

G-BWR

35225

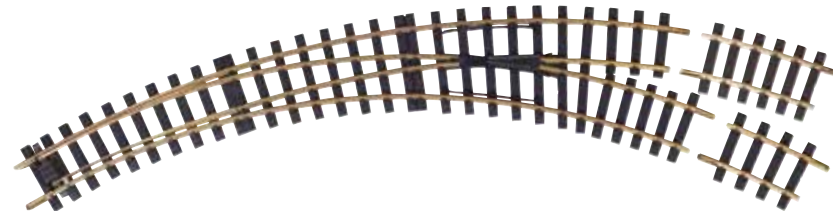

35225 Manual Curved Switch, Right R3-R5

Inner Curve = Curve R3, 52.5°

Radius 36.26", 921 mm

Outer Curve = Curve R5, 37.5°

Radius 47.24", 1200 mm

Package includes R3 7.5° and R5 7.5°

Compatible electric switch machine #35271

Flexible Track

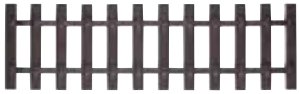

G-SB320

35230 Tie Strip, 12.66"

Tie strip for construction of flexible track. Matches to a rail length of 12.66" mm (321,54). G-SB320 + G-SB280 make up the module length of 23.62" (600 mm)



G-SB280

35231 Tie Strip, 10.96"

Tie strip for construction of flexible track. Matches to a rail length of 280 mm (10.96"). G-SB280 + G-SB320 make up the module length of 23.62" (600 mm)



G-P3000

35250 Rail Section, 118.11"

Rail section for construction of flexible track. Use 2 x 35250 together with 5 x G-SB280, 5 x G-SB320, 18 pcs. of metal tie joiners from #35291 and 2 pcs. of metal rail joiners from #35290 to make approximately 118" (3 m) of track.



G-P1500

35251 Rail Section, 5"

Rail section for construction of flexible track. Use 2 x 35251 together with 3 x G-SB280, 2 x G-SB320, 8 pcs. of metal tie joiners from #35291 and 2 pcs. of metal rail joiners from #35290 to make approximately 59" (1.5 m) of track.



35285 Track Clips, 14 Pieces

Use to secure track sections together on temporary layouts.



35290 Metal Rail Joiners, 20 Pieces

Sturdy brass material to securely join rails. For replacement or for use with flexible track.



35291 Metal Tie Joiners, 20 Pieces

Sturdy brass clips to join flexible tie sections.

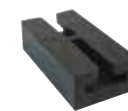

35292 Insulated Rail Joiners, 6 Pieces

Insulated joiners made of ultra-violet- and weather-resistant plastic.

35293 Rail Clamp On-Rail, 10 pieces

This clamp is designed to fit directly on the rails for the best connection. Fits PIKO and most other Code 332 rails.

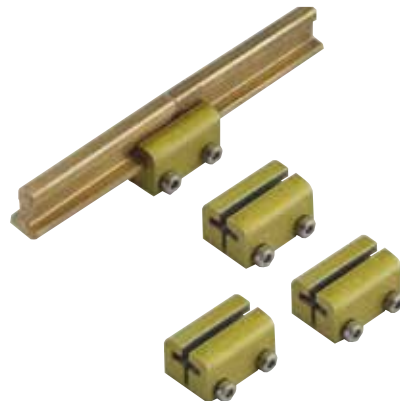

35294 Rail Clamp Over-Joiner, 10 pieces

This clamp fits over the existing rail joiner, to allow easy installation on an existing layout, or to avoid removing existing rail joiners. Fit over PIKO and most other rail joiners. Check fit on other brands before tightening.





35280 Bumper
 Typical railroad end-of-track bumper.
 Secures easily to track.

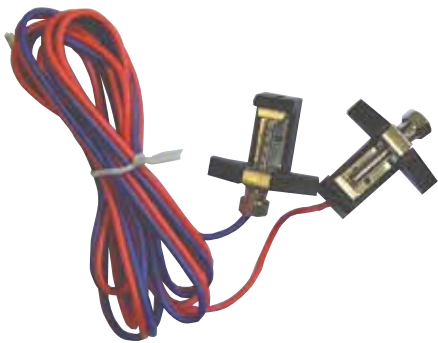

35270 Power Clamp, 1 Pair
 With heavy-duty cable. Use for track
 power connection.

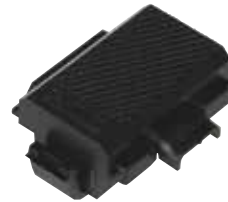

35268 Track Magnet
 For triggering Reed Switch contacts, such as #35267 to
 activate locomotive bell and whistle/horn sounds.



35269 Loco Magnet
 For triggering track contact #35272, adhesive-backed,
 58 x 24 x 3 mm

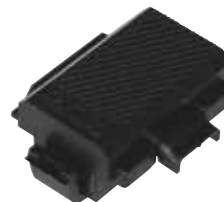

35272 Track Contact
 Single-pole double-throw momentary reed-switch con-
 tact for controlling switches, signals and other accesso-
 ries, triggered by the loco magnet #35269

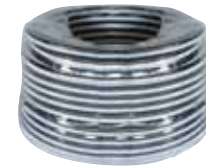

35400 Black/White Cable 25 m
 Cross-section 1,5 mm², UL2468
 16AWG



35401 Blue/Red Cable 25 m
 Cross-section 1,5 mm², UL2468
 16AWG



35402 Orange/White Cable 25 m
 Cross-section 1,5 mm², UL2468
 16AWG



35265 Relay Contacts DPDT

These double-pole double-throw relay contacts mount to the PIKO #35271 Switch Machine and can be used for many automatic control functions.



35266 Switch lantern, lighted

Lighted lantern mounts to PIKO #35271 Switch Machine and changes to indicate setting of switch points.



35271 Electric Switch Machine

Water-proof electric switch machine for all PIKO switches. Also fits LGB* and can be adapted to some other brands.

Contents:

- 1 x Front end 113 x 416 mm
- 1 x Rear end 113 x 402 mm
- 1 x End part 113 x 27 mm

35281 Rerailer / Grade Crossing with American and German Crossing Signs



Contents:

- 2 x Side Ramp Pieces
- 1 x Center Rerailer Piece
- 1 x 35200 Track G320
- 2 x US Railroad Crossbucks
- 2 x German Railroad Crossing Signs

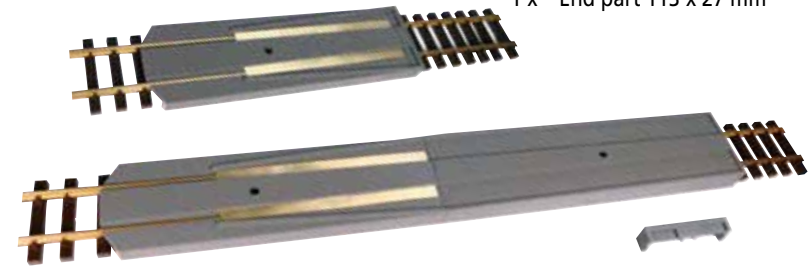

35282 Powered Rerailer

Our powered rerailer makes it easy to put any locomotive on the track. With large multi-wheeled locos, it can be a real challenge to get all the wheels correctly on the rails. And while a garden railway can be great fun, bending down in the rocks and dirt to put trains on the tracks is not fun. That struggle is now a thing of the past! Set the rerailer down on a powered track and the built-in contacts automatically pick up power from the rails. Just place a loco down on the rerailer - no need to fuss with accurately aligning wheels—and it rolls down onto the track under its own power. The PIKO powered rerailer features a short version for smaller locos, plus a snap-on extension for those really long locos. And it works just as well for freight and passenger cars of any size.



ca. 322 x 155 x 130 mm
12.7 x 6.1 x 5.1 "
Track length = G-320 12.6" (320 mm)

* LGB is a trademark of Gebr. Märklin & Cie, GmbH

TRACK SETS – EXPAND YOUR RAILROAD EMPIRE

The PIKO G-Track sets allow beginners as well as experienced modellers to build up a basic stock of track elements at a reasonable price, when starting with the PIKO G-track system. The uncomplicated, clear design of the PIKO G-Track system makes it possible to continuously extend existing layouts by adding further sets. The sets

contain the color coded pieces shown in the graphics below. The white sections are the typical starter set circle. The color coding conforms to the PIKO G-Track color coding system. The switches contained in the Track Sets can be converted to electric operation at any time by installing an electric switch machine.

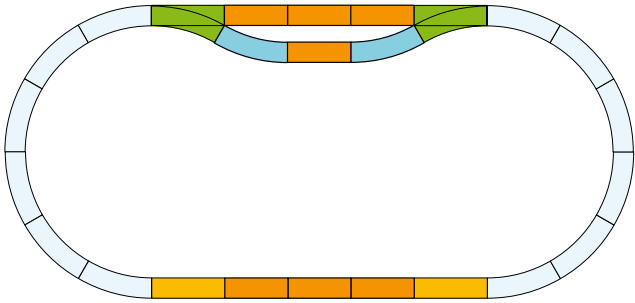

35300 Station Track Set

- 1 x 35220 WLR1 (Switch left)
- 1 x 35221 WRR1 (Switch right)
- 2 x 35211 R1 (Curved track R1 23.62")
- 2 x 35200 G320 (Straight track 12.60")
- 7 x 35201 G280 (Straight track 11.02")
- Floor area: 9.19' x 4.26'
- Minimum area for assembly: 9.84' x 4.92'

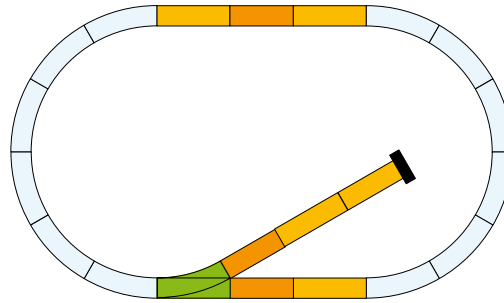

35301 Siding Track Set

- 1 x 35280 Buffer Stop
- 1 x 35220 WLR1 (Switch left)
- 5 x 35200 G320 (Straight track 12.60")
- 3 x 35201 G280 (Straight track 11.02")
- Floor area: 7.38' x 4.26'
- Minimum area for assembly: 8.04' x 4.92'

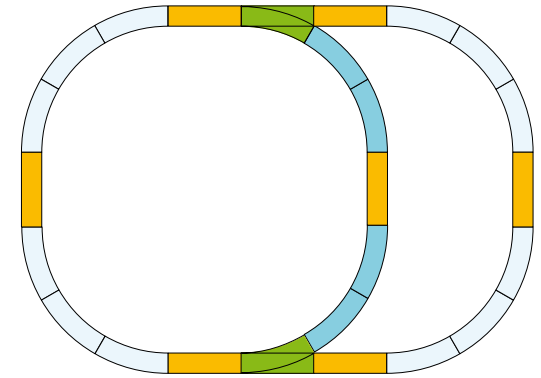

35302 Double Oval Track Set

- 1 x 35220 WLR1 (Switch left)
- 1 x 35221 WRR1 (Switch right)
- 4 x 35211 R1 (Curved track R1 23.62")
- 7 x 35200 G320 (Straight track 12.60")
- Floor area: 7.55' x 5.25'
- Minimum area for assembly: 8.20' x 5.91'

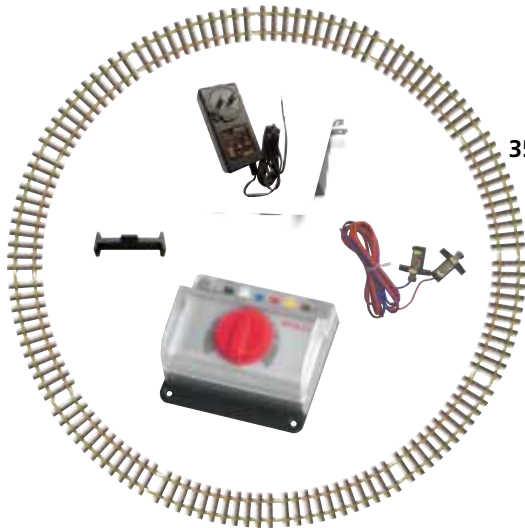

35310 Track and Power Set

- 12 x 35211 R1 (Curved Track R1 23.62")
- 14 x Track Clips
- 1 x Power Clamp w/Wires
- 1 x Analog Throttle, Basic
- 1 x Safety Approved 120 V Transformer
24 V / 45 VA
- Floor area: 4.26' x 4.26'
- Minimum area for assembly: 4.92' x 4.92'



Using PIKO G-Track in conjunction with LGB** track

PIKO G-Track Code 332 brass rail and rail joiners are fully compatible with LGB track. PIKO G-Track sections can be easily integrated into existing LGB** track layouts. The following charts show how the track sections compare to each other.

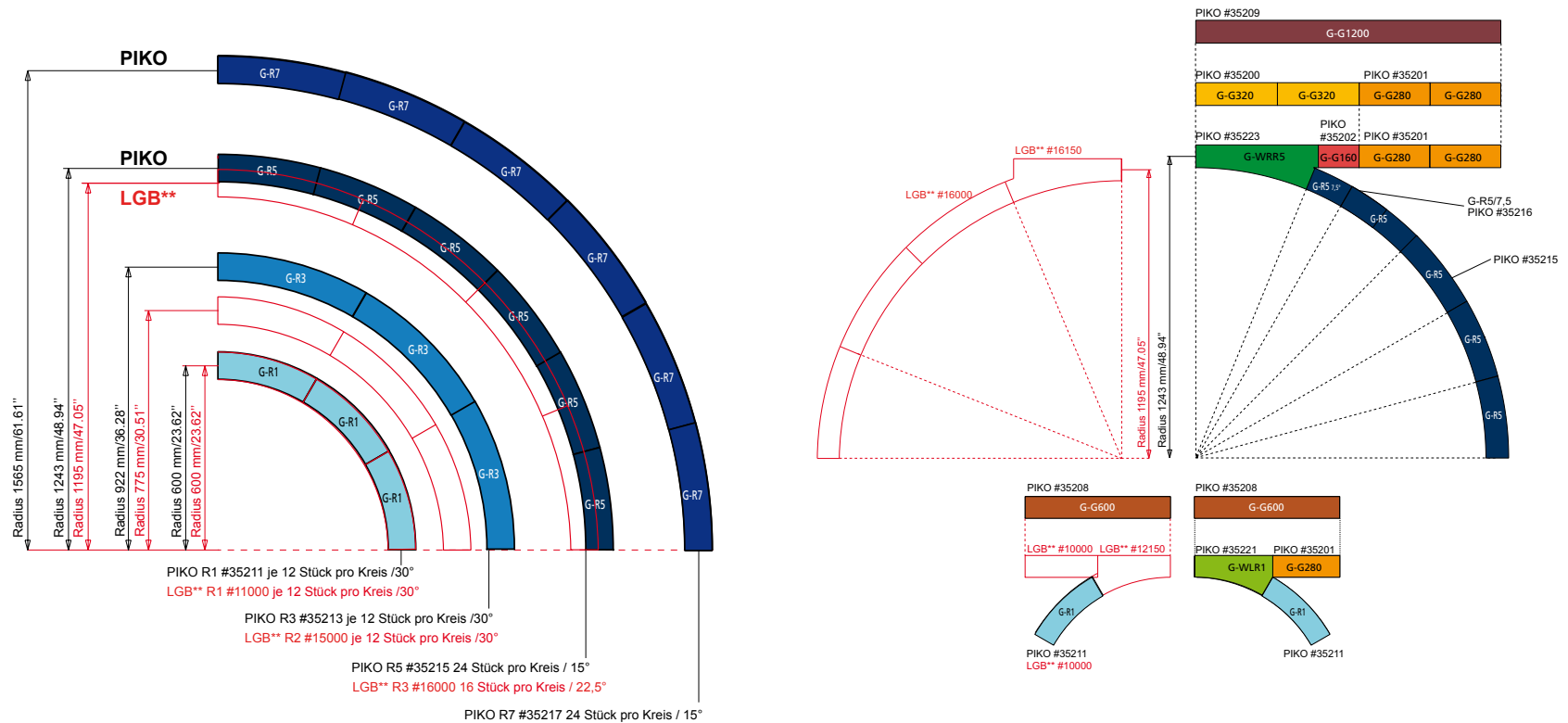

PIKO #35209 1200 mm / 47.24"	PIKO
G-G1200	
LGB** #10610 1200 mm / 47.24"	LGB**
PIKO #35208 600 mm / 23.62"	PIKO
G-G600 G-G600	
LGB** #10600 600 mm / 23.62"	LGB**
PIKO #35200 320 mm / 12.66" PIKO #35201 280 mm / 10.96"	PIKO
G-G320 G-G280 G-G320 G-G280	
LGB** #10000 300 mm / 11.81"	LGB**
PIKO #35202 160 mm / 6.33" PIKO #35203 140 mm / 5.48"	PIKO
G-G160 G-G140 G-G160 G-G160 G-G160 G-G140 G-G140	
LGB** #10150 150 mm / 5.91"	LGB**

** LGB is a trademark of Gebr. Märklin & Cie. GmbH



LOCOMOTIVES

- > Powerful five-pole precision can-type motor
- > Exceptional pulling power
 - > Concealed electrical pickups on driving wheels
 - > Spring-loaded sliding pickup shoes
 - > Precise paint schemes and lettering



See this and more great locomotives on the following pages.

Back by Popular Demand!

Track Cleaning Function!

NEW 2024

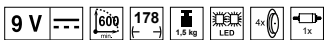

38508 Clean Machine Green (non-R/C), Battery Powered

The PIKO Clean Machine

With the "Clean Machine" version of the GE 25-Ton diesel, PIKO brings you a completely different concept in track cleaning. Track cleaning operation is simple - just let it run around the layout till even heavily oxidized track is polished clean. Once the Clean Machine has cleared the way, track-powered locos can run smoothly!

The Clean Machine Green is powered by 6 common household 'AAA' batteries (not included, high-capacity rechargeable cells are recommended), which provide up to two hours of running time for cleaning even large layouts. The front "radiator panel" of the engine hood opens for easy access to the quick-change battery clip.

The economical Clean Machine Green offers incredibly simple operation. Select 'Forward' or 'Reverse' with the switch under the cab and let it roll. The switch also includes a center 'Off' position to park the loco when not in use.



35416 Track Cleaning Shoes, Clean Machine, 2 sets

Package of 4 cleaning shoes with very long-lasting, highly-effective mesh cleaning pads. Clever snap-on / -off installation makes changing cleaning shoes quick and easy, with no tools or disassembly required.



38506 Clean Machine 25-Ton Diesel, Battery R/C



38515 UP 25-Ton Diesel, Battery R/C w/Sound

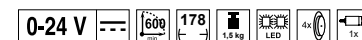

38502 Blue Goose 25-Ton Diesel (non-R/C), Track-Powered

25-TON DIESEL LOCOS WITH DIGITAL SOUND

All 25-Ton Diesels on this page include:



These 25-Ton diesel models come with factory-installed R/C plus remote-controlled sound functions, all powered by 6x high-capacity AAA rechargeable batteries (not included). The amazing sound system was created by TCS and PIKO America. Bell and Horn sounds are triggered by the included pocket remote, with numerous other automatic and fully authentic 25-Ton diesel sounds.

The included pocket remote gives easy walk-around radio control of the loco's speed, direction, and an emergency stop function. 8 R/C channels allow operation of multiple locos independently. Or, multiple locos can be set to the same R/C channel and run together from one remote.

**NEW
2024**



38514 WP&YR 25-Ton Diesel, Battery R/C w/Sound

**NEW
2024**



38513 D&RGW 25-Ton Diesel, Battery R/C w/Sound



38511 US Army 25-Ton Diesel, Battery R/C w/Sound



38509 SF 25-Ton Diesel, Battery R/C w/Sound



38512 KLV Thumper 25-Ton Diesel, Battery R/C w/Sound



38510 PRR 25-Ton Diesel, Battery R/C w/Sound

For 38231, 38235, and 38237:



☒ 38231 PRR Mogul #889 with w/Smoke and Digital Sound



38235 C&S Mogul Loco #3 w/Smoke and Digital Sound

The sound-equipped steam locos on these two pages include:

- › Bright, Directional LED Lights and 5-Volt Smoke System
- › High-Volume 3-Watt Digital Steam Sound System, with:
 - Synchronized Steam Exhaust Chuff
 - Correct Bell and Whistle Signals
 - Dynamo, Blower, Air Pump and Steam Release
 - Brake Squeal and Brake Release
 - Coal Shoveling (on coal-fired locos)
- › Built-in 'dual-mode' decoder for full-feature operation on either Analog DC or Digital DCC

**NEW
2024**



38237 D&RGW Mogul Loco #223 w/Smoke and Digital Sound

MOGUL LOCOS WITH SMOKE AND SOUND



Celebrating the elaborate adornments on locomotives of the late 1800s, The Union Pacific and Santa Fe Moguls on this page feature completely original Western art paintings by a talented artist, commissioned exclusively for PIKO and reproduced in beautiful full color on the tender sides as only PIKO can do.

38233 SF Mogul Loco #704 w/Smoke and Digital Sound



38236 UP Mogul Loco #1209 w/Smoke and Digital Sound

For 38230, 38233 and 38236:

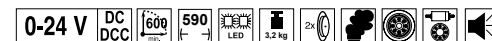

38230 North Pole Express Mogul w/Smoke and Digital Sound

**NEW
2024**



38260 WP&YR Mini-Mogul Loco #53 w/Smoke and Analog Sound

**NEW
2024**

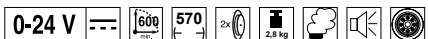

38261 UP Mini-Mogul Loco #1213 (Non-Sound)



38238 SF Mini-Mogul Loco #718 (Non-Sound)



38239 D&RGW Mini-Mogul Loco #247 (Non-Sound)

Powerful, reliable, economical locos for your railroad:

- › The locos on these two pages include well-proven and smooth-running PIKO gear drives with precision can-type motors and 8-point electrical pickup. All include directional "golden glow" LED headlights and nicely detailed valve gear.
- › 38238, 38239 and 38261 are ready for installation of a 36220 Digital Steam Sound Kit and 36142 Smoke Unit.
- › Plastic tender wheels can be easily replaced with 2 packs of 36164 Metal Wheelsets if desired.
- › Both 38255 and 38256 feature a 5-Volt Smoke System and Analog Steam Sound.
- › To activate bells and whistles, place 35268 Track Magnets at desired locations around the layout.



38255 D&RGW 0-6-0T Loco w/ Smoke and Analog Sound



38256 UP 2-6-0T Loco w/Smoke and Analog Sound



37210 DB III Steam loco BR 64 with switchable chassis lighting and smoke

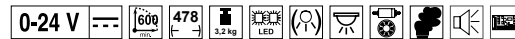

37212 OeBB III BR 64 Steam loco with switchable chassis lighting and smoke

All BR 24 / BR 64 locos include:

- › Finely detailed superstructure
- › Numerous separately applied railings and pipes
- › Openable smokebox door
- › Clear view through detailed cab interior
- › Detailed spoked wheel centers with stainless steel tires
- › 7-pole ball-bearing Bühler motor
- › Complete and detailed valve gear
- › Switchable 5-volt smoke generator
- › Directional LED lighting
- › Engineer figure
- › Prepared for the installation of the PSD XP 5.1 S #36522. The requirement is that the locomotive is equipped with the Connector 36510.

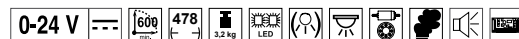

37214 Steam locomotive Class 64 DR III



37222 DR III BR 24 Steam Loco, Wagner Smoke Deflectors with Smoke

Suitable Accessories:

#36510 Connector PCB for PSD XP

#36500 PSD XP

#36522 PSD XP
S BR 24 Sound



37223 Steam Locomotive Class 24 DB III



37246 DR III BR 50 Steam Loco with Smoke

Prototype

The class 50, built from 1939 onwards, is one of the most frequently built German freight locomotives and was, for a long time after the war, one of the most important supports in freight traffic in East and West Germany. Locomotives of this class were also used in other countries, in some cases until the end of the steam locomotive era. The light and comparatively fast locomotives were used as universal locomotives in the course of time before almost all types of trains. The 50s even mastered individual express and D trains with excellence.

Model

The lovingly implemented model in the respective harmonious design has a finely detailed overall appearance corresponding to the model, and can be used in many ways due to its excellent driving characteristics. Many applied details (e.g., wind deflectors, sand pipes and the applied number plate on the smoke chamber door) underline the noble character of the locomotive. The model has fine replicas of the handlebars and filigree spoke wheels with stainless steel tires as well as a light change white/white. The analog version is, of course, prepared for upgrading a digital system and sound. The heavy PIKO model has two traction tires. The plastic parts are made of a special material for a long-lasting outdoor garden. The features of the driver's cab lighting, the smoke set and the flickering light in the fire box are switchable by means of a function key (with the digital version) or a switch (analog).

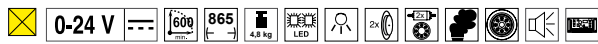

37240 DR IV BR 50 Reko Steam Loco with Smoke



37242 DB IV BR 050 Steam Loco with Smoke

Ready for easy installation of cab light, digital decoder and sound.

Suitable Accessories:

#36510 Connector PCB for PSD XP

#36500 PSD XP

#36530 PSD XP
S BR 50 Sound



Prototype

The tank locomotive of the class 95 started service as class T20 in early 1923. It was able to pull 2060 tons at 31mph on flat terrain. After WWII, 14 of the 45 machines were used by the German Federal Railways. Their operation included helper service on grades. The last locomotive was retired in 1958 from service by the Federal Railways. After the war, the Deutsche Reichsbahn received 31 locomotives of the BR 95 class. To increase capacity in the early 1970s, the tonnage per train was raised for the BR 95. Several locomotives are preserved in museums. Engine 95 027 is operational and can be seen in service from time to time today.

Model

PIKO's model of the BR 95 shows all the prototype's relevant details, down to the finest paint and print features. It excites with a prototypical, but yet finely detailed appearance and versatile use. Also impressive are the machine's robustness, precisely manufactured wheels with stainless steel tires, and a very reliable power pick-up. The 37232 model is factory-equipped with not only a smoke unit, but also with a digital decoder and sound, offering many sound functions on analog DC as well as digital DCC operation.

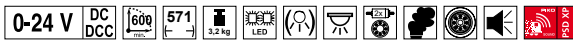

37232 DR IV BR 95 Steam Loco, New construction boiler oil with Sound

Model

PIKO makes it possible to have a model of the famous “Rennsteighirsch” train in your own backyard! Our BR 94.5 steam locomotive is a most welcome addition to G scale. The model is a fine example of prototype fidelity married to robust design, which guarantees plenty of play value. The durable locomotive is tough enough for the challenges of extended outdoor operation and at the same time is highlighted by sophisticated features like a glowing red firebox and a factory-installed smoke unit. The BR 94.5’s articulated chassis allows it to operate over small radii and its innovative axle bearings keep its electrical wipers in good contact with the rails.

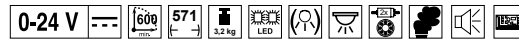

37252 DB III Class 94 Steam Loco

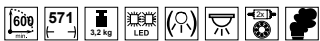

DR IV-VI BR 94 Steam Locomotive

37250 0-24 V **Non-Sound**

37251 0-24 V **Sound**

All BR 95 / BR 94 locos have:

- › Finely detailed superstructure
- › Numerous separately applied railings and pipes
- › Openable smokebox door
- › Clear view through detailed cab interior
- › Detailed spoked wheel centers with stainless steel tires
- › 7-pole ball-bearing Bühler motor
- › Complete and detailed valve gear
- › Switchable 5-volt smoke generator
- › Directional LED lighting
- › Engineer figure
- › 37250, 37252 are prepared for installation of either a 36500 non-sound decoder or 36521 sound decoder kit.

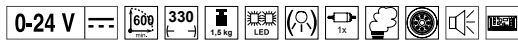

37202 DB III BR 80 Steam Loco



37821 DR IV Snow Plow



Jubilee Design:

This special design celebrating PIKO's 75th anniversary will be revealed later in the year!



**NEW
2024**



37585 PIKO 75th Anniversary BR 131 Diesel Loco

**NEW MOLD
2024**



Photo: Günter Postel

The Prussian T 9.3 loco was built in the thousands between 1900 and 1914. What eventually became BR 91.3 of the DR served faithfully on branch lines for decades, pulling freight, passenger and mixed trains. Some lasted in regular revenue service into the early 1970s.

0-24 V

37260 DR III BR 91.3 Steam Loco (Non-Sound)

0-24 V

37261 DR III BR 91.3 Steam Loco, Sound

**NEW
2024**



Photo: Altmark-Rail GmbH

A series of roughly 160 diesel locos was built in the late 50s to early 60s by the Swedish firm Nydqvist och Holm AB. The common nickname "NoHAB" comes from their initials. These were built for railroads in several European countries, under license from the leading US locomotive maker of the era, the Electro Motive Division of General Motors. They feature an adaptation of the classic F-Unit "bulldog" nose, but with a cab on each end. Similar to American "E-Units", the trucks are A1A-A1A wheel arrangement, with the extra axles helping to spread out the weight for European track with lighter axle ratings.

In more recent years, several NoHAB diesels have been maintained and offered for lease service by the northern German firm Altmark-Rail. The standard Altmark dark red paint scheme is handsome. But loco 1149 was given a special Christmas-themed "Winter" paint scheme, which has made it a favorite with fans young and old.



PIKO brings you this beautiful model to help celebrate the season on your G-Scale railroad.

0-24 V

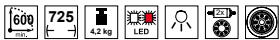
37452 Altmark-Rail VI NoHAB Diesel Locomotive 1149, Winter



Diesel Locomotive NoHAB Strabag VI

37450 0-24 V    Non-Sound

37451 0-24 V    Sound-Equipped

Prototype:

One of the most striking diesel locomotives on European tracks is undoubtedly the "NoHAB". This is an offshoot of the legendary F series of the US manufacturer EMD, which was built from 1954 onwards by the Swedish licensee Nydqvist och Holm AB, or "NoHAB" for short. Until 1965, the manufacturer delivered 165 examples of the locomotives affectionately known as „round noses“ to the state railroads in Denmark, Norway and Hungary. Additional examples were built for the Belgian state railroads by the manufacturer Anglo-Franco-Belge. The vehicles differed in various details, such as the installed engine power, but shared the same design principles and the beautifully shaped locomotive body. The locomotives performed extremely well and were used in various services. Their service in Denmark and Belgium lasted until the late 1980s and for about ten years longer in Norway and Hungary. Through the liberalization of the European rail market, many locomotives found new jobs with private companies in Germany as well, and some of them are still in commercial service today.

Model:

There is no accounting for taste, but there are things whose elegance is beyond all doubt. The PIKO model of the NoHAB can also profit from the undisputed elegance of the prototype. To achieve this overall impression, great attention has been paid to details. The side ventilation grilles are used as strong dividing elements of the locomotive body with fine etched parts and are an absolute eye-catcher. But the distinctive front side windows as well as the side „portholes“ also contribute to the excellent image due to their perfectly flush fit. Thanks to two powerful engines and finely tuned gear ratios, the model has excellent driving and pulling characteristics. The various lighting functions spread a pleasant atmosphere even in the dark. This model is rounded off by the gritty, clear sound of the sound model, which is in no way inferior to the prototype.

⇒ Now available in G-scale: the observation car class 491 glass train of the Deutsche Bundesbahn



DB IV Glass Train

37330 0-24 V Non-Sound

37331 0-24 V Sound-Equipped

Model:

With our "glass train," PIKO has brought another piece of railroad history to G-scale. The glass car body allows for a full view of the detailed interior, which includes factory-installed figures and interior lighting.

The engineer's control stand is also illuminated. The headlights and taillights change from red to white with the direction of travel. For operation in Austria, an SBS 65 single-arm pantograph was installed on the prototype in 1976. The Era IV model includes this feature. Other roof equipment like cables and insulators are faithfully reproduced. A powerful Bühler motor provides the "glass train" with plenty of heft, and two additional pick-up shoes have been added to ensure a constant power supply. The digital version of the ET 91 is factory-equipped with a sound decoder and features a digitally-controlled pantograph. The analog version can be converted to digital and sound operation.

Prototype:

In 1935, for the 100th anniversary of the German railways, the Fuchs Railcar Works of Heidelberg was commissioned two self-propelled observation cars for the purpose of sight-seeing trips. The German Reichsbahn classified these cars as ET 91. Designed to provide passengers with a panoramic view, as many surfaces as possible were comprised of glass, including parts of the roof. Their appearance earned them the nicknames "glass train" or "rolling glass box" or "the glass one." The Reichsbahn hoped the new railcars would win back passengers from bus travel, so fares for the new cars were advertised as 33% lower compared to third class fares.

The total length of the railcars was approximately 20 m (65 ft.). They originally had a top speed of 120 km/h (75mph). This was later reduced to 110 km/h (68mph). One car could accommodate a maximum of 72 people. One railcar was completely destroyed during the war. The other was repainted and returned to service by the German Federal Railroad. The original color scheme was probably light blue, and later changed to dark blue. In 1953 the ET 91 became the BR 491 and the car was given a red/ivory paint scheme. In 1971 it was painted Olympic Blue for the Olympic Games. The car last wore a dark blue paint scheme. The story of the remaining "glass train" ended tragically during a panoramic trip in 1995, when it was totaled in an accident at Garmisch-Partenkirchen. After 60 years of operation, one of DB's oldest pieces of rolling stock was retired permanently.

All BR 103 include:

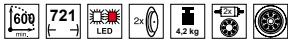

Suitable Accessories:

#36510 Connector PCB for PSD XP

#36500 PSD XP



#36530 PSD XP
BR 103 Sound



Prototype

For many years, the six-axle class 103 electric locomotives were regarded by the Deutsche Bundesbahn as the flagship in heavy passenger train traffic and represent one of the most popular German locomotive series. The DB used four pre-series models as high-speed locomotives from 1965, and by 1974 a total of 145 additional series locomotives were in operation. With a continuous output of 7,440 kW (10,116 hp), the 103s are still among the most powerful one-piece locomotives. The first series locomotives were delivered with scissor pantographs, from 1976 onwards SBS65 single-arm pantographs were used. In addition, the locomotives lost their front skirts and received buffers without cladding. With their elegant and timeless design, the noble racers shaped the high-quality travel traffic for many years and became cult objects already during their regular service. From 1997 onwards, the 103s were gradually phased out until 2003 and replaced by the new 101 series. Several locomotives are preserved in museums.



37441 DB IV BR 103 Orient Red w/Bib and Single-Arm Pantograph



37440 DB IV BR 103 Electric Loco



0-24 V

37443 DB IV BR 103 Electric Lufthansa, Sound



RailAdventure VI BR 103 Electric Loco

37444 0-24 V Non-Sound

37442 0-24 V Sound

Suitable Accessories:

#36511 Connector PCB for PSD XP

#36500 PSD XP

#36541 PSD XP
BR 194 Sound



37437 Electric Locomotive Class E94 DR III

The German BR 194 was built by AEG starting in 1940. The 128t six-axle electric locomotive was designed for freight service but was used in passenger and express train service as well. By the end of WWII a total of 146 locomotives were delivered to the then DRG. Between 1954 and 1956 the DB ordered a further two batches of locomotives numbered E 94 178 – E 94 196 and E 94 262 – E 94 285 to alleviate a shortage of powerful freight locomotives. For the same reason a further four used BR 194s were purchased from the Eastern German DR.

The PIKO model shows a high level of detail. The fan louvers, rows of rivets, grab irons, and metal pantograph are all meticulously reproduced, yet robust enough for garden railroading. Two gearboxes with ball bearing equipped motors ensure excellent pulling performance.



37432 Electric Loco BR 254 "Crocodile" DR IV



37429 Flixtrain VI Taurus Electric Loco

**NEW
2024**



37401 DB VI BR 182 Taurus Electric D-Ticket

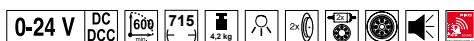

37400 ÖBB VI RH 1116 Taurus Electric Railjet, Sound

Suitable Accessories:

#36511 Connector PCB for PSD XP

#36500 PSD XP



#36534 PSD XP
Taurus Sound

The PIKO model of the Taurus electric loco is striking, and extremely so in the bright green livery advertising the modern DB AG "D-Ticket" special price travel offer.

The Austrian Federal Railways Railjet service started in 2008. It uses modern and powerful Rh 1116 "Taurus" electric locomotives and conventional passenger cars, as opposed to other modern articulated trains like the ICE3. The attractive maroon, red and gray Railjet paint scheme is a popular sight in and around many cities, such as Vienna, Salzburg and Munich.

The PIKO model of the Railjet Taurus loco comes factory-equipped with a DCC decoder and authentic digital sounds of the real loco.

For matching Railjet passenger coaches, see page 77

Suitable Accessories:

#36510 Connector PCB for PSD XP

#36500 PSD XP

#36535 PSD XP
BR 218 Sound



NEW
2024

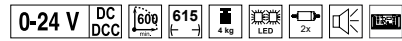

37513 DB VI BR 218 Diesel Locomotive



37512 DB V BR 218 Diesel w/Bib, Sound

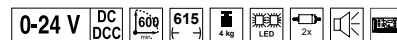

37511 DB VI BR 218 497-6 PIKO/Märklin Diesel Locomotive



37584 Diesel Locomotive BR 232 EBS VI



37583 DR IV BR 132 Diesel with Sound

Suitable Accessories:

#36510 Connector PCB for PSD XP

#36500 PSD XP



#36526 PSD XP
BR 132 Sound



Model

PIKO's attractive Garden Scale models of the BR 130/131/132 family of diesel locomotives fulfill the wishes of numerous G-scalers around the world who love these big diesel locomotives. The PIKO Ludmillas feature sturdy trucks, separately-applied handrails, and all the external details of their respective 1:1 prototypes. Internally, the models feature detailed engine rooms and cab interiors with engineer figures. Lighting features include directional headlights and taillights that change over depending on the direction of travel, and digitally-activated high beams. Engine room lighting can be added if desired. The impressive BR 130/131/132 from PIKO boast a high tractive force and exceptional running characteristics thanks in part to their chrome-plated wheelsets that ride on ball bearings. Each locomotive is factory-equipped with digital sound so you can bring the typical sounds of the "Ludmilla" to your G-scale layout.

Suitable Accessories:

#36510 Connector PCB for PSD XP

#36500 PSD XP

#36533 PSD XP S BR 106



Prototype

As early as 1953, the Deutsche Reichsbahn had plans drawn up for a new diesel loco to replace old worn-out locomotives in switching service. LKM Babelsberg led the development, which produced two prototype locos in 1958. Series production began in 1962. Some operating experience led to design improvements. The V60.12 series, known from 1970 on as the BR 106 class, provided a new engineer's cab with enhanced protection from the elements for the crew. The locos went on to prove themselves quite well in decades of service on the DR. Some are still used today in railway construction and industrial service.

Model

With the model of the BR106, PIKO brings to market another classic of the DR, and another model requested by many fans. The PIKO BR106 faithfully reproduces the looks of the real thing. And the robust construction features hard chrome-plated wheels with ball-bearings on the geared axles, directional LED lights and an engineer figure in the cab. The appearance is further enhanced with many individual details, such as handrails, windshield wipers, and the fascinating siderods and eccentric crank of the drive mechanism. The non-sound version is ready for easy installation of a digital decoder and sound unit. The sound version is factory-equipped with a digital decoder and sound system for an extra touch of realism.



DR IV BR 106 Diesel

37590 0-24 V Non-Sound

37591 0-24 V DC DCC Sound-Equipped

**NEW
2024**

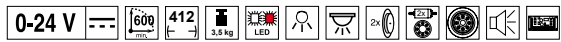

37594 SKL VI BR V60 Diesel Locomotive (Non-Sound)



37592 DR III BR V60 Diesel, Sound

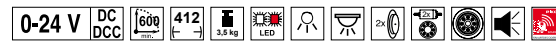

37593 Press VI BR 346 Diesel, Sound

Suitable Accessories:

#36510 Connector PCB for PSD XP

#36500 PSD XP

#36539 PSD XP
Sound BR 260



37550 DB III V20 Diesel Switcher

Model

The PIKO V20, the little sister to the 3-axle V 36, is another very versatile locomotive choice for the garden-rail-roading enthusiast. The locomotive can be used as switcher or as road engine pulling short passenger or freight trains. Both axles of the small and nimble PIKO locomotive are driven. The jackshaft with its rotating counter weight between the axles is a special eye-catcher. Just like the PIKO V36 before, the PIKO V20 correctly reproduces the many louvers and vents that are typical for the prototype. The model features separately applied grab irons. It is equipped with white directional lighting, prepared for DCC conversion and can be fitted with diesel sound.



37532 DB III Diesel Locomotive BR 236, with Cupola



Suitable Accessories:

#36510 Connector PCB for PSD XP

#36500 PSD XP



#36539 PSD XP
Sound BR 260



#36540 PSD XP Sound V100/BR199

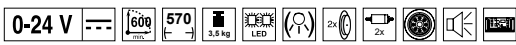

37568 DR IV BR 110 Diesel Wine Red



37560 DB AG V Diesel Loco BR 204



37543 HSB V BR 199 Harzkamel



37526 DB IV BR 260 Diesel

Suitable Accessories:

#36510 Connector PCB for PSD XP

#36500 PSD XP



#36543 PSD XP
TEE Diesel Sound



#36523 PSD XP
TEE Turbine Sound



Diesel VT 11.5 TEE Train

The streamlined diesel-powered VT 11.5 trainsets developed in the 1950s were the flagships of the Deutsche Bundesbahn. These brought increased comfort to the premier international Trans-Europe Express (TEE) service. The PIKO model brings this unique train to life in G-Scale. Both end-units are powered and equipped with hard-chrome plated wheels and ball bearings on driven axles. The trainset is equipped with directional head- and taillights as well as prototypical interiors. It can be fitted with sound, a digital decoder, and interior lights.



37320 DB III TEE Diesel VT 11.5 3-Unit Train

Turbine BR 602 TEE Train

The power cars for four VT 11.5 train sets were rebuilt in 1970 with gas-turbine engines, for more power and higher top speed. Externally, these have distinctive "air scoops" on their noses. The sound decoder kit includes the unmistakable turbine sound.



37321 DB IV TEE Turbine BR 602 3-Unit Train



37308 DB III Raibus VT98

Suitable Accessories:

#36510 Connector PCB for PSD XP

#36500 PSD XP

#36536 PSD XP Sound

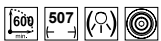

37690 DB III VS98 Railbus Trailer-Only



37309 DB IV BR798 Railbus & Trailer, Mint Green, Sound



PASSENGER CARS

- > Precision engineering
- > Excellent running characteristics
 - > High level of detail and precise scale proportions
 - > Elaborate paint schemes
 - > Fine lettering



See this and more great passenger cars on the following pages.

Available for all American Passenger Cars:

© #36164

Suitable Accessories:

#36136 interior lighting is available for all Wood Drover's Caboosees

Interior Lighting Kit #36135 is available for all American-style wood coaches, combines, and baggage cars.

Car numbers shown may not be current. See description for car number.



38600 D&RGW Wood Coach 284



38601 D&RGW Wood Combine 209



38237 D&RGW Mogul 223 w/Sound and Smoke (see page 39)



38602 D&RGW Wood Drover's Caboose 215 with Metal Wheelsets and Lighted Markers

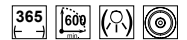

38603 D&RGW Wood Baggage Car 127



38610 D&RGW Wood Coach 337





38231 PRR Mogul w/Sound and Smoke
(see page 38)

Suitable Accessories:

#36136 interior lighting is available for all Wood Drover's Caboosees
Interior Lighting Kit #36135 is available for all American-style wood coaches, combines, and baggage cars.



38659 PRR Wood Combine 22610



38660 PRR Drovers Caboose 21015 with Metal Wheelsets and Lighted Markers

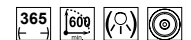

38658 PRR Wood Coach 23119



38657 PRR Wood Coach 23117



Available for all American Passenger Cars:  #36164

Suitable Accessories:

Interior Lighting Kit #36135 is available for all American-style wood coaches, combines, and baggage cars.



38652 NYC Wood Combine 215



38650 NYC Wood Coach 286



38651 NYC Wood Coach 287





38626 SF Wood Baggage Car 72493



38628 SF Wood Coach 16521



38663 SF Wood Coach 110212



38664 SF Wood Coach 110154



38665 SF Wood Combine Car 111543



38666 SF Wood Drivers Caboose 112505 with Metal Wheelsets and Lighted Markers



Available for all American Passenger Cars:  #36164

Suitable Accessories:

Interior Lighting Kit #36135 is available for all American-style wood coaches, combines, and baggage cars.



38260 WP&YR Mini-Mogul 53
(see page 41)



38667 WP&YR Wood Coach 308



38668 WP&YR Wood Coach 330





38236 UP Mogul 1209 w/Smoke & Digital Sound
(see page 40)

Suitable Accessories:

#36136 interior lighting is available for all Wood Drover's Caboose
Interior Lighting Kit #36135 is available for all American-style wood coaches, combines, and baggage cars.



38653 UP Wood Coach 1873



38654 UP Wood Coach 1878



38655 UP Wood Combine 1922



38656 UP Wood Drovers Caboose 1953 with Metal Wheelsets and Lighted Markers

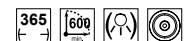

Available for all American Passenger Cars:  #36164

Suitable Accessories:

Interior Lighting Kit #36135 is available for all American-style wood coaches, combines, and baggage cars.



38235 C&S Mogul 3 with Digital Sound and Smoke
(see page 39)



38661 C&S Wood Coach 77



38662 C&S Wood Coach 71



 38647 C&S Wood Baggage Car 4



38645 C&S Wood Combine 20



EUROPEAN PASSENGER CARS

Available for all Silver Coin Cars:  #36165

Interior Lighting for Silver Coin Coaches: #36132



37630 DB IV Silver Coin Coach ABnd, 1./2. cl.

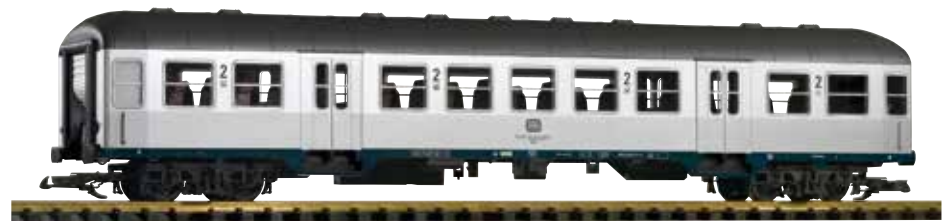

37631 DB IV Silver Coin Coach Bnd, 2. cl.



37632 DB V 2. Cl. N-Car Mint Green



37633 DB V 1./2. Cl. N-Car Mint Green



37636 DB V Control Car Wittenberg Mint Green

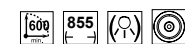

Available for European Passenger Cars: © #36165



**NEW
2024**

37015 TRI VI 2nd Class Coach

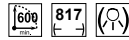

**NEW
2024**

Photo: Henning Folz

37676 DB VI 2nd Class IC Control Car



**NEW
2024**

37016 TRI VI 1st/2nd Class Coach

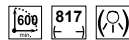

**NEW
2024**

37672 DB VI 1st Class IC Passenger Car



**NEW
2024**

37637 TRI VI Control Car Wittenberg

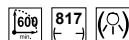

**NEW
2024**

37671 DB VI 2nd Class IC Passenger Car



MODERN IC PASSENGER CARS

Interior lighting #36132

For all Cars available: #36165

**NEW
2024**



37670 DR IV Halberstädter Passenger Car

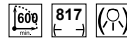

37668 DB IV 2. Cl. Coach Bpmz Lufthansa

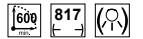

37675 ÖBB VI Control Car, Railjet

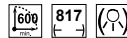

37663 DB IV Passenger Coach Apmz 1. Cl.



37665 ÖBB VI 2. Cl. Coach, Railjet



37667 DB IV 1. Cl. Coach Apmz

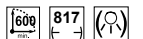

37666 ÖBB VI 1. Cl. Coach, Railjet



37664 Flixtrain VI Passenger Coach



37669 ÖBB VI Buffet Car, Railjet



Available Interior Lighting: #36137, 36138

Available for European Passenger Cars:  #36165



37651 DR IV Reko BDghwse 2. Cl. Combine



37652 DR IV Reko WRge Diner MITROPA



37650 DR IV Reko Bghwe 2. Cl. Coach



37656 DR III Reko 2. Cl. Combine



37657 DR III Reko Diner MITROPA



2- & 3-AXLE REKO PASSENGER CARS

Prototype:

By the 1950s, the Deutsche Reichsbahn was in great need of modern passenger cars. Like the Deutsche Bundesbahn, the DR decided to upgrade existing 2- and 3-axle wooden Länderbahn coaches to contemporary standards. Each car was stripped down to its frame and rebuilt to a uniform 13,820 mm (45 ft) length, 3043 mm (10 ft) width, and 4000 mm (13 ft) height. Single doors were installed on the front right-hand side and every car received electric lighting. The first ReKo (ReKonstruktion) cars entered service in 1959, and after a trial period went into production in 1960. The cars spread quickly throughout East Germany and soon formed the backbone of DR's passenger car fleet. They became the quintessential commuter car and could be found in all metropolitan areas of the DDR, where some trains consisted of up to 10 cars. Retirement of the ReKo coaches began in the 1980s and finished in the mid-1990s.

Available Interior Lighting: #36131

Available for European Passenger Cars:  #36165

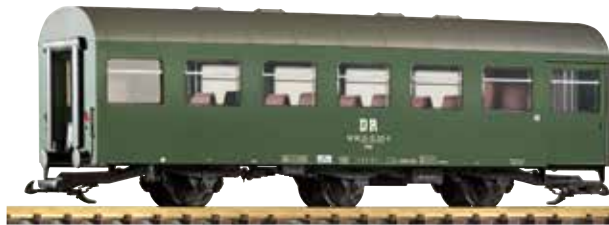

37680 DR IV Reko 3-Axle Coach Bage



37681 DR IV Reko 3-Axle Coach Bagtre

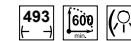

37682 DR IV Reko 2-Axle Coach Baage



37683 DR IV Reko 3-Axle Baggage Dage

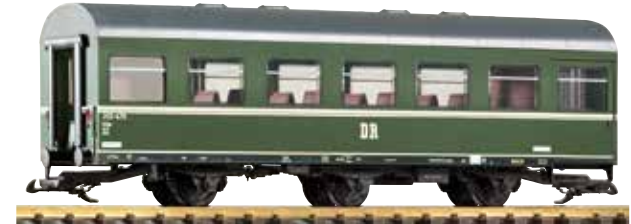

 **37684 DR III Reko 3-Axle Coach Bage**



 **37685 DR III Reko 3-Axle Coach Bagtre**



37686 DR III Reko 2-Axle Coach Bage



37687 DR III Reko 3-Axle Baggage Dage



Available Interior Lighting: #36131

Available for European Passenger Cars:  #36165



37600 DB IV 3-Axle Umbau 2. Class Car



37611 3-Axle Umbau 2. Class Car DB IV



37601 DB IV 3-Axle Umbau 1.-2. Class Car



37602 DB IV 3-Axle Umbau Combine



37920 DB III 2-Axle 2. Cl. Coach



37926 DR III 2-Axle Coach



37928 2-Axle 2. Cl. Coach DB III





37840 DR IV Baggage Car



37842 DR III Baggage Car



**NEW
2024**



37843 MWB V Baggage Car



37841 Measuring Car Pwg88

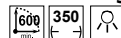

PIKO introduced the outstanding smart measuring car in HO-scale, and G-scale enthusiasts begged for this innovation as well. PIKO has provided!

Measure your entire garden railroad accurately from measurements of scale miles all the way down to a centimeter. Track gradients can also be measured. All measured data displays in realtime on the SmartPhone app (Android or Apple iOS) or the PC app. Additional data, like the average train speed, can be saved and analyzed on your PC. Data is measured from every inch of trackage, not just visible track. The high-tech Measuring Car is based on actual DB AG Geometry Cars, including prototypically accurate paint scheme and factory-installed interior lighting.

Integral display screen

- › Switchable lighting

Display of measured data

- › Actual train speed (cm/s, m/s, km/h, mph)
- › Distance traveled (cm, m, km, miles)
- › Total distance with zeroing function

Onboard data storage

- › Option to read measurement data without WiFi connection

Integral backup battery

- › Ability to measure dead track sections

Integral USB port

- › Memory read out
- › Battery charging port

Grade percentage measurement

Analog and digital operation



FREIGHT CARS

- > Precision engineering
- > Excellent running characteristics
 - > High level of detail and precise scale proportions
 - > Elaborate paint schemes
 - > Fine lettering



See this and more great freight cars on the following pages.

Available for all American Freight cars:  #36164

**NEW
2024**

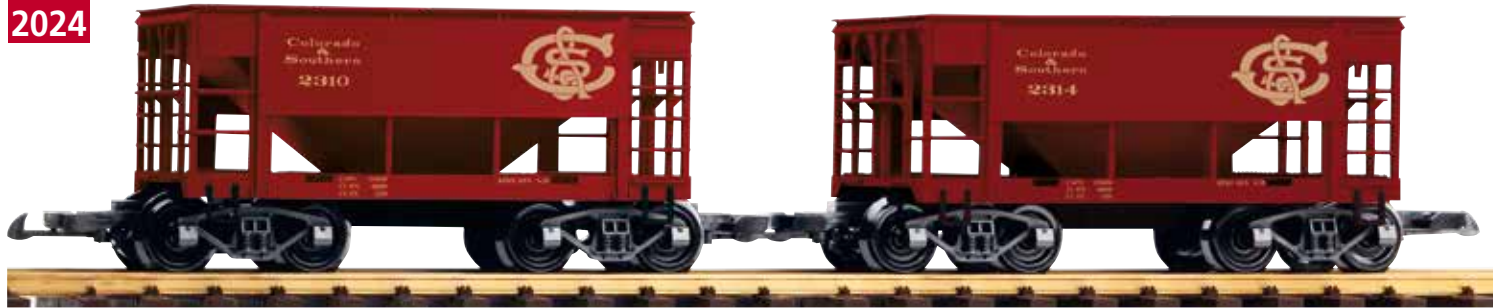

38952 C&S Ore Car, 2-Pack

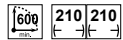

38933 Chessie-B&O Ore Car, 2-Pack

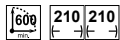

38931 D&RGW Ore Car, 2-Pack

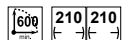

ORE CARS

**NEW
2024**



38953 CSX Ore Car, 2-Pack

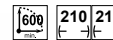

38950 UP Ore Car, 2-Pack

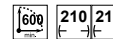

38915 North Pole Express Ore Car, 2-Pack

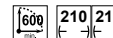

38951 Christmas Ore Car, 2-Pack

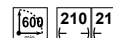

36311 Ore Car Load

Weather-resistant injection-molded plastic insert. Realistic representation of a load of raw iron ore. Made to fit PIKO ore cars. Light weight helps avoid the car becoming top-heavy and unstable.



38913 SF Ore Car with Ore Load



Available for all American Freight cars:  #36164

**NEW
2024**



38792 UP Tank Car



**NEW
2024**



38796 ESSO "Tiger" Tank Car



38775 Sunoco Tank Car



 38781 Texaco Tank Car 1975



VINTAGE WARBIRDS HOPPER CARS



38938 Vintage Warbirds P-40 Hopper



Honoring the Greatest Generation
and the planes that made history.

- Photo-realistic graphics!
- Original licensed artwork!
- Produced only once!



38903 Vintage Warbirds P-47 Hopper



38909 Vintage Warbirds F4U Hopper



38928 Vintage Warbirds Spitfire Hopper



38910 Vintage Warbirds P-38 Hopper



38921 Vintage Warbirds B-25 Hopper



38956 Vintage Warbirds F6F Hopper



38925 Vintage Warbirds SBD Hopper



38940 Vintage Warbirds C-47 Hopper



38939 Vintage Warbirds B-17 Hopper





36312 2-Bay Hopper Car Load

Weather-resistant injection-molded plastic insert. Realistic representation of a load of coal. Made to fit PIKO two-bay rib-side and offset-side hopper cars. Light weight helps avoid the car becoming top-heavy and unstable.



38924 Chessie-C&O Rib-Side Hopper with Coal Load



**NEW
2024**



38964 WP&YR Rib-Side Hopper 8385 with Coal Load



**NEW
2024**



38955 PRR Rib-Side Hopper 209912 with Coal Load, Brunswick



38954 UP Offset-Side Hopper 27511, Flag



Available for all American Freight cars:  #36164

**NEW
2024**



38959 D&RGW Rib-Side Hopper 12881 with Coal Load

**NEW
2024**



38960 UP Rib-Side Hopper 97158 with Coal Load



 38918 SF Rib-Side Hopper with Coal Load



 38930 Grandpa's Naughty List Cartoon Hopper with Coal Load



38934 CSX Rib-Side Hopper 811001 with Coal Load



38825 PRR Steel Boxcar 81374

362 600



38831 UP Steel Boxcar 120152

362 600



38926 SF Steel Boxcar 11527

362 600



38965 SF Chieftain Reefer

362 600



38885 CB&Q Friendship Train Boxcar

362 600



38809 D&RGW Boxcar

362 600

"AMERICAN TRADITIONS" REEFERS

Available for all American Freight cars: #36164

The American Traditions series recalls many significant icons of American history, culture and heritage. Each car features original artwork commissioned from a fine artist exclusively for PIKO, and reproduced in beautiful full-color as only PIKO can do.



38922 American Traditions Betsy Ross Reefer



38941 American Traditions John Henry Reefer



38942 American Traditions Independence Reefer



38923 American Traditions Baseball Reefer

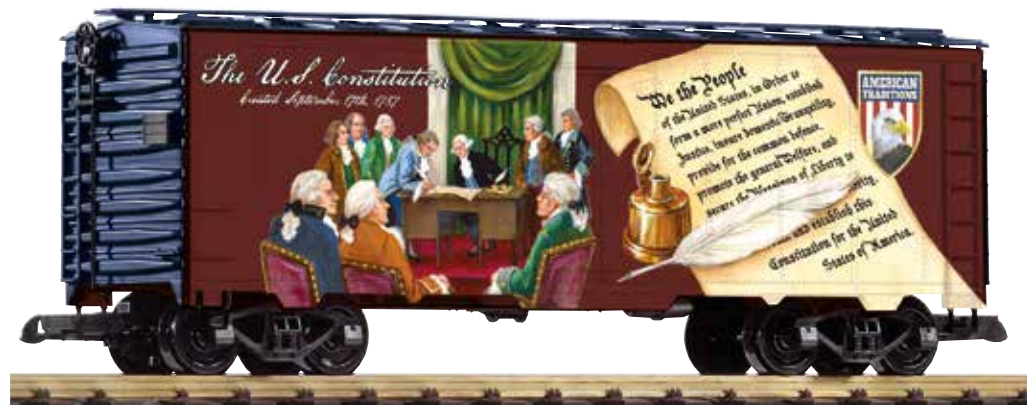

38943 American Traditions Constitution Reefer



**NEW
2024**



38962 RR Nostalgia "Commodore" Boxcar

362 600



38786 SF Flatcar w/Redwood Log Load

368 600



38963 RR Nostalgia "The Real McCoy" Reefer

362 600



38788 Sun and Surf Auto Transport

368 600



✘ 38789 Golf Cart Transport

368 600

FLATCARS WITH LOADS

Available for all American Freight cars:  #36164

**NEW
2024**



38791 UP Bulkhead Flatcar w/Pulwood Log Load



**NEW
2024**



38795 D&RGW Bulkhead Flatcar with Pipe Load



 **38754 PRR Low-Side Gondola with Roof Trusses**



38732 SF Container Car



36302 Container 20', Undecorated White

302 x 103 x 111 mm
11.9 x 4.0 x 4.4"

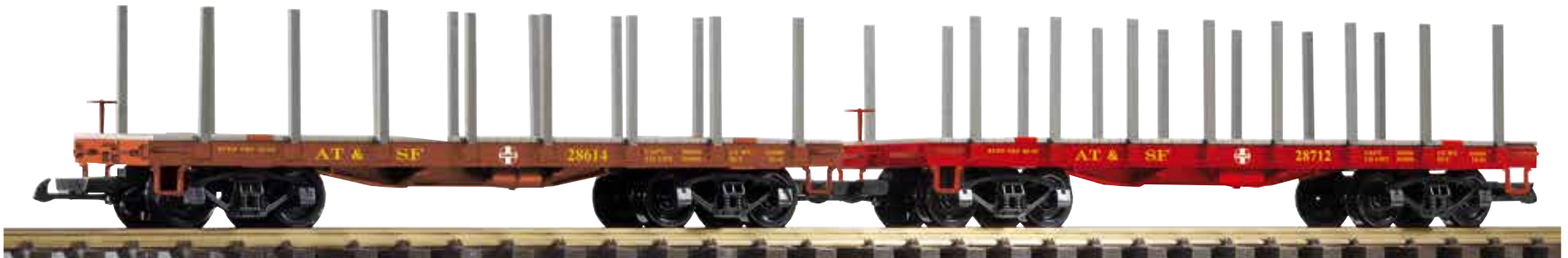

38773 SF Flatcar w/Stakes, 2-Pack



38774 UP Flatcar w/Stakes, 2-Pack

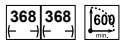

38778 D&RGW Flatcar w/Stakes, 2-Pack



Available for all American Freight cars:  #36164

**NEW
2024**

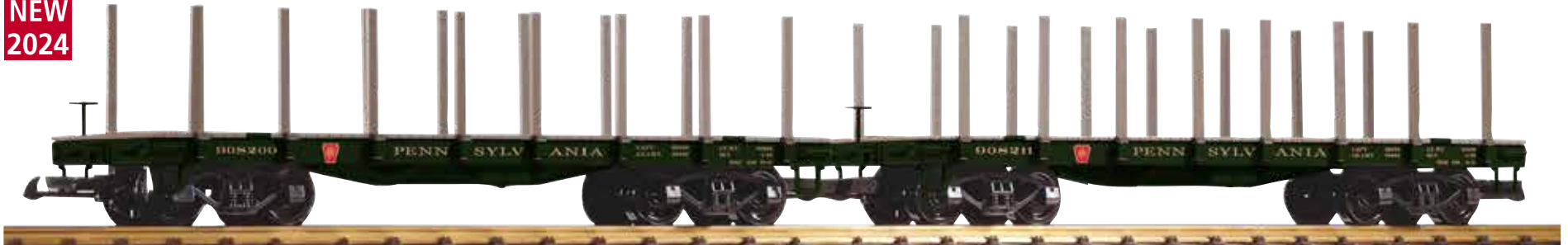

38784 PRR Flatcar w/Stakes, 2-Pack , Brunswick



**NEW
2024**

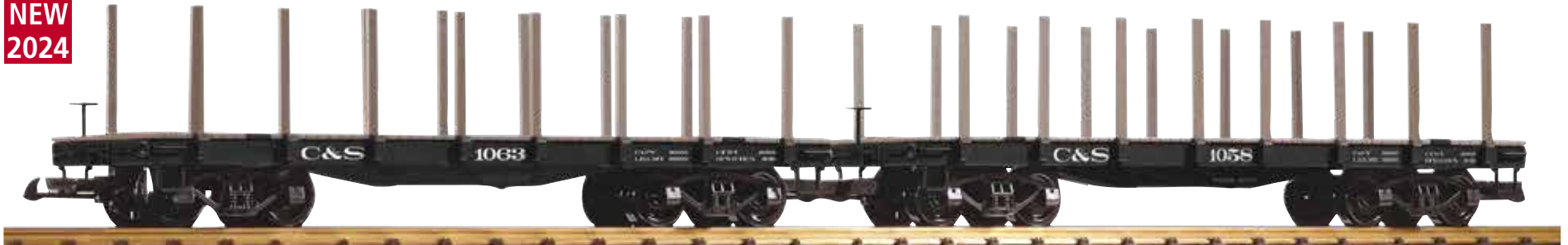

38785 C&S Flatcar w/Stakes, 2-Pack

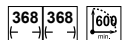

All items on these two pages feature removable/positionable stakes.



 38779 PRR Flatcar w/Stakes, 2-Pack, Tuscan



Due to their weight and the absence of pneumatic brakes, freight trains had to be slowed down, when necessary, one car after the other. Another risk of freight and passenger trains was caused by overheating bearings and oil lamps tipping over. Switches had to be worked, lighting provided and passengers and freight handled. The cabooses served as a working and living place for the indispensable conductors, signalmen, shunters, brakemen, locomotive engineers and firemen, especially on long-distance journeys. Tools and spare parts were also stored and transported here. In order to have a better view, an elevated superstructure, called a cupola, was added to the roof of many cabooses. For shorter distances, a caboose without a cupola, called a transfer caboose, was often used.



38945 SF Wood Caboose



Use the 36250 lighting kit to light the marker lamps and add to the cabin of this work caboose.



38790 Halloween Work Caboose



Available for all American Caboosees:  #36164



38948 UP Wood Caboose



38969 C&S Wood Caboose



38946 PRR Wood Caboose



38947 D&RGW Wood Caboose



Available for all 2-Axle European Freight cars:  #36165



 37850 DR IV Self-Unloading Hopper



37851 DB III Self-Unloading Hopper



**NEW
2024**



37852 Bahnbau VI Self-Unloading Hopper



**NEW
2024**



37853 Press VI Self-Unloading Hopper



Prototype and Model:

During the 1920s, the Deutsche Reichsbahn received their first self-discharging hopper cars that were used for ballast service. The biggest innovation on these cars was a sophisticated system of hand-controlled chutes that allowed the operator to direct the flow of ballast to the inside or outside of the rail. When designing our G-scale Otm hopper car, we decided that we would include this same feature on our model! You too can spot our G-scale Otm at a worksite on your garden railroad, and dump sand and fine gravel on your G-scale right-of-way using the Otm's miniature chutes.

GONDOLAS

Available for all 4-axle European freight cars: #36164



37749 FS IV Gondola Eaos



37010 SBB VI Eaos Gondola Gray



**NEW
2024**



37018 DR IV Eaos Gondola



37012 DB VI Eaos Gondola



37013 SBB VI Eaos Gondola



There is a different design on each side of 37013.



37754 Container Car with 2 20' Containers DB AG VI



37011 ÖBB V Flat w/Container



37707 DB AG V Flatcar



Available for all 4-axle European freight cars:  #36164

**NEW
2024**



37017 On Rail VI Tarp Car



37720 Track Cleaning Car, 2 Track Cleaning Pads and 100 ml Cleaning Fluid included. See page 121 for additional track cleaning supplies.



37748 Wascosa VI Tarp Car Shimmns-tu 718



37724 DB V Tarp Car Shimmns Cargo



NEW
2024



37965 DR III G10 Boxcar Born

350 600

37972 DR III 2-Axle Boxcar VEB PIKO

600 350



37966 DR III G10 Boxcar Fit

386 600



37955 DR III Stock Car, moveable doors

600 350



37960 DB IV 2-Axle Boxcar w/Brake Platform

600 386

Available for all 2-axle European freight cars:  #36165

**NEW
2024**



37832 DR III 2-Axle Emergency Tank Car



37971 DR III Tank Car Minol



37968 DB III 2-Axle Boxcar w/Brake Platform



37956 2-Axle Tank Car Buna DR IV



 37967 DB IV 2-Axle Tank Car Eva



Available for all 4-axle freight cars:  #36164

Available for all 2-Axle Freight Cars:  #36165



37963 DR IV 2-Axle Gondola



37962 DR III Acid Tank Car w/Brake Cab



37969 Acid Tank Car w/Brake Cab DRG II



**NEW
2024**



37973 DB III 2-Axle Gondola



37800 DB III Ore Car OOt96



**NEW
2024**



37797 SBB V Cement Silo Car



37796 DR IV Cement Silo Car Gray Chassis



37773 DR IV Coal Container Car w/Brake Platform



The imaginations of young (and not-so-young!) model railroaders can run wild with a train car that can be built and rebuilt any way they want. Using their favorite building blocks, the possibilities are endless with the PIKO building block car. Model railroading with PIKO has never been more fun!



Building blocks not included



37970 Building Block Car (Building blocks not included)





PIKO POWER & ACCESSORIES

- > Multiple Systems / Multiple Options:
 - > Power for Indoors and Outdoors
 - > Simple R/C for All Power Types
 - > Factory-Equipped R/C
 - > PIKO G-Digital for DCC
 - > Components for Battery, DC, DCC and R/C



35028 R/C Analog Track Power Set, 5A / 120V w/Pocket Remote

- **NO Loco Modifications**
- **Run almost any Analog DC train.**

Set includes 22V / 5A / 120V Transformer, R/C Controller and Pocket Remote.

- **Easy:** Simple 4-button Pocket Remote gives you precise control of speed and direction, an emergency stop for safety and a fixed DC accessory output on/off, all from a compact remote control.
- **Flexible:** 8 selectable channels give you options – Use the 8 channels to control locos or consists independently, or set R/C Controllers to the same channel to control multiple tracks at once.
- **Powerful:** The 22 Volt / 5Amp Transformer provides big power. The R/C Controller will provide up to 4.5 Amps to the track and up to 2.0 Amps of fixed DC for accessories. (5 Amps max continuous output.)
- **Reliable:** The Pocket Remote offers up to 80' / 25m wireless walk-around range from the R/C Controller. Uses radio control so it works in daylight and around corners - no need for "line of sight".

The 35028 is not recommended for use with decoder-equipped locomotives.



35040 R/C Loco Receiver, 3,5 A, w/Pocket Remote

The 35040 R/C Loco Receiver offers all the operational features of the R/C Controller in the 35028 set, with extra benefits:

- The R/C Loco Receiver is compact and fits most G-Scale locos. The main receiver board is only 2.8" x 1.2" x 0.6".
- Includes two relay-type function contacts for controlling horn/whistle and bell on a separate sound unit.
- Designed to be easily battery-powered (minimum 7v batteries. Batteries not included)
- Alternately, the Receiver can be powered by a fixed, well-filtered DC supply of 7 to 22 volts, such as a DC voltage on the track.
- The Receiver has simple, user-friendly connections for motor/lighting power and the two function outputs.
- Includes 35041 Pocket Remote - see features on page 109

With the 35040 R/C Loco Receiver and batteries installed in your G-Scale loco, the included pocket remote allows you to operate your train virtually anywhere - over dirty track, non-powered track, even across the floor!

35040 is not recommended for use with decoder-equipped locomotives.





35041 R/C Pocket Remote

Additional remote for 35028, 35040, 35042 and R/C starter sets. Extra remotes are ideal for more operators and can replace lost or damaged remotes. 8 selectable R/C channels allow for multiple trains and/or operators. Includes push-button controls for two relay-type functions such as horns/whistles and bells. Up to 80'/25m range, indoors or outdoors.

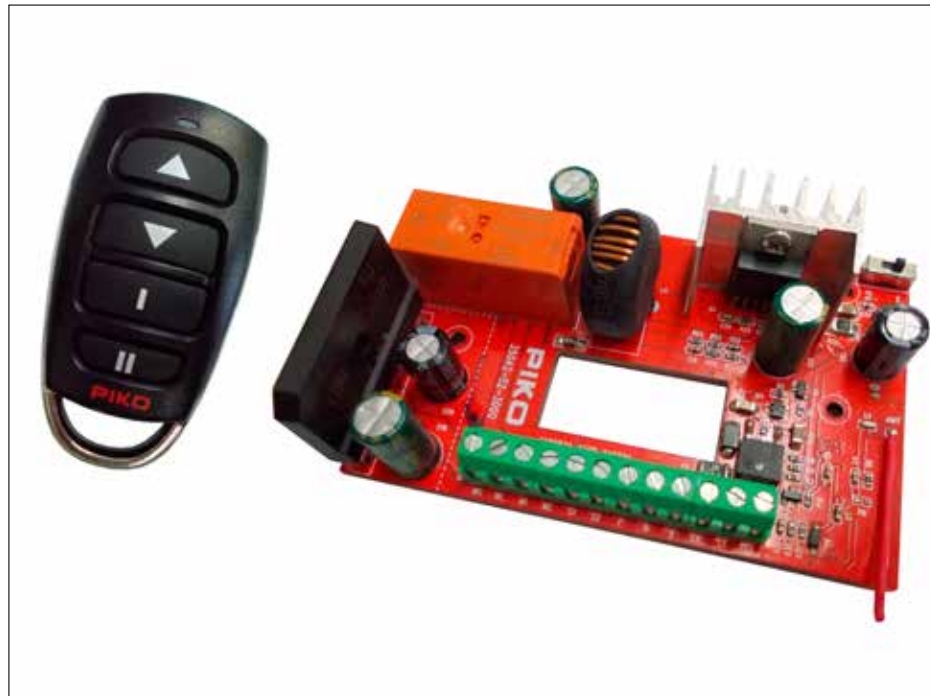

35042 R/C Loco Receiver 5A, Pure DC with Remote

The 35042 R/C Loco Receiver takes onboard PIKO R/C to a new level!

- › The Receiver provides up to 5A (6A peak power) with a "Pure DC" output safe for the Analog operation mode of most DCC decoders, including the popular PIKO 36220 steam sound decoder kit.
- › The Receiver board is designed for easy installation inside many G-Scale locos. The Receiver board measures 3.38" x 2.16" x 1.06" (86x55x27mm)
- › Includes two relay-type function contacts for controlling horn/whistle and bell on a separate sound unit.
- › The built-in rectifier allows the Receiver board to operate on 12-18V AC / 12-24V DC 6A for usage with digital equipment (for good performance min 18V AC / DC recommend), from either onboard batteries or constant track voltage.
- › Includes Mode switch to select voltage output range, starting either at 0.5V for locos without internal voltage drop circuits, or at 6V for decoder-equipped locos with a higher startup voltage.
- › Receiver PCB includes wiring access cut-out for easy installation in locations such as tenders with wires coming up through the floor.
- › Easy screw-terminal connections for motor, lighting and two function outputs.
- › 8 selectable R/C channels. Set up to 8 different locos to different channels for independent operation, or set any number of locos to the same channel for multiple-unit lashups.
- › Includes 35041 Pocket Remote—see features above.



Another industry First from PIKO!

25-Ton diesel locos factory-equipped for full battery-powered operation, with PIKO R/C and realistic TCS digital sound built-in. Run the train over any track—clean, dirty or unpowered, even across the floor! It's all controlled from the convenient Pocket Remote, included with the loco.

Six standard size 'AAA' batteries (not included, high-capacity rechargeables are recommended) allow for long running time. The quick-change battery clip is located inside the engine hood and the front panel snaps off for easy access. 8 selectable R/C channels allow running multiple locos independently, or controlling multiple locos together in one train consist. What could be more fun than one PIKO 25-Tonner? A double-header, triple-header, or more!

In addition to the bright directional LED constant lights and cab interior light, the highly realistic digital sound is completely new, a joint development of PIKO and TCS, a name already well-respected for digital sound decoder technology. Numerous authentic sounds function automatically. And if the powerful high-fidelity sound becomes a bit much, there's an easily-reached volume control in the loco cab.

Press a button to turn on the bell as the train pulls out of a station. Press again to turn it off. Press and hold another button to blow the horn as long as desired. Give the correct two blasts when starting in forward, and three in reverse, or a few quick warnings to clear the tracks. Even blow the grade crossing pattern of two longs, a short and a long blast. And this realistic control is easy with just one hand, at up to 80' range—unaffected by daylight and big enough for the great outdoors.

All these locos come with the easy-to-use Pocket Remote. See 35041 on page 109 for more details.

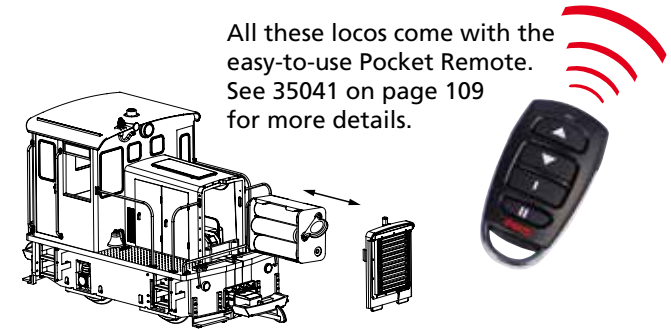

Clean Machine R/C

The 38506 "Clean Machine R/C" adds another dimension—a battery-powered, radio-controlled track cleaning loco. Track cleaning operation is simple—just let the loco run around your layout (either in forward or reverse) till even heavily oxidized track is polished clean. Once the Clean Machine has cleared the way, track-powered locos can run smoothly. With the convenience of PIKO R/C built-in, you can run the loco into a stub-end siding track and then back out of the siding, or park the loco in the engine house when you're done cleaning track. This loco can also function as a normal loco, just like a real "25-Tonner", pulling a few cars around the layout.



38506 Clean Machine R/C operation, completely battery-powered (Non-Sound)



38509 SF 25-Ton Diesel Battery R/C w/Sound



38510 PRR 25-Ton Diesel Battery R/C w/Sound

See pages 36-37 for additional 25-Ton Diesels factory-equipped for Battery R/C Sound operation.



38511 US Army 25-Ton Diesel Battery R/C w/Sound



38512 KLV Thumper 25-Ton Diesel Battery R/C w/Sound

ECONOMICAL POWER, ALL IN ONE PACKAGE



35027

35027 45 Watt Analog Power Set, 120 V

Transformer: 120 V AC
Safety-Approved
Switching Power Supply
Output 24 V DC / 45 VA
Electronic Throttle:
Output 0-22 V DC / 1.5 A,
Constant 16 V DC / 0.4 A

BIG POWER FOR LARGER LAYOUTS



35002

35002 Analog Throttle

Electronic controller for analog operation. Requires a transformer, such as 35024.
Input: max. 18 V / 5 A AC or max. 24 V / 5 A DC
Output: 0-22 V / max. 5 A DC
Add wireless control for up to 8x 35002 Analog Throttles with the 35037 Navigator Remote and 35038 Wireless Receiver. See page 112.



35024

35024 Power Supply 120 VA

The ideal power supply for the 35002 Analog Throttle. Provides a full 5 amps output at 24VDC. Not for use with Digital systems.
Input: 120 V AC
Output: 24 V / 120 VA DC

SEPARATE POWER COMPONENTS

35006 Basic Analog Throttle

Electronic controller for analog operation
Requires a transformer, such as 35025.

Input:
max. 24 V / 1.9 A DC only
Output:
0-22 V / 1.5 A DC,
constant 16 V DC, 0.4 A



35006



35025

35030 Analog Reversing Unit

The PIKO Analog Reversing Unit contains:

- Splash-proof electronics
- Insulated track joiners
- Track hook-ups with cable

Using the Analog Reversing Unit, your train can automatically shuttle between two train stations.

It features the following functions:

- Smooth acceleration and deceleration
- Adjustable waiting time in train stations
- Overload and short circuit protection
- Requires a well-filtered DC power supply of 12-24 Volts.

Notice! This product cannot be used with digital/DCC, multi-train systems.



35030

35025 Power Supply 45 VA

Power supply for PIKO analog throttle 35006 and Switch Control Boxes 35260 and 35261
Input: 120 V AC
Output: 24 V / 45 VA DC

TAKE CONTROL OF YOUR LAYOUT



35260

35260 Switch Control Box

Weather-resistant control for operating
4 switches or signals
Input: 0-24 V DC-only



35261

35261 On/Off Control Box

Weather-resistant control with 4 double-pole on/off switches to control 4 different electric circuits, such as tracks or lights.
Input: 0-24 V AC or DC

The PIKO G-Digital System gives independent control of multiple trains on the same track. PIKO G-Digital is fully NMRA-compliant DCC (Digital Command Control) and can reduce complex block wiring and insulated track sections. Track voltage is kept constant at roughly 22V and each locomotive decoder receives signals and responds to user commands, including operating lighting functions or installed sounds.

The PIKO G-Digital System includes four main components:

- › 35020 Transformer (Providing reliable power to the system)
- › 35010 Digital Central Station (The brain, sending commands to the track)
- › 35037 Navigator Remote (An ergonomic remote)
- › 35038 Wireless Receiver, Optional (For wireless operation)

Switch Decoders, Boosters and more devices can always be added on to customize your layout.

35037 Navigator Remote

The Navigator Remote can be used with the PIKO G-Digital System or the 35002 Analog Throttle. The large backlit display enables clear operation. The Navigator Remote allows assigning each loco an icon and name for clear identification. It can also control switches on DCC layouts.

The Navigator Remote can be connected via the included cable or can be operated wirelessly by adding the 35038 Wireless Receiver.



35010 Digital Central Station

The Digital Central Station receives signals from the Navigator Remote and controls operations on your layout. The Digital Central Station takes the input from one or more Navigators and converts it to digital commands that it sends out with track power. The digital commands are addressed to specific decoders, and decoders ignore any command not addressed to them, so only the selected loco or accessory will react to your input.

Input: 16-20 V DC, max. 5 A

Output: Up to 27 V DCC regulated, max. 5 A



35010

35020 Power Supply 120 VA

The ideal power supply for the 35010 Digital Central Station and 35015 Digital Booster. Provides a full 6 Amps output at 20V DC.

Input: 120 V AC

Output: 20 V / 120 VA DC



35020

35038 Wireless Receiver

The splash-protected Wireless Receiver converts the radio signal from the Navigator into either a digital signal for the 35010 or an analog signal for the 35002. The Receiver includes the correct cables and employs bidirectional FM radio technology that allows for reliable operation for up to 300 feet. (100m)



35038

INFO

- › Large backlit display with easy, menu-based control
- › Locomotive configuration with alpha-numeric names and pictograms
- › 10,239 locomotive addresses
- › 14, 28 and 128 speed step capability
- › 2048 switch/accessory addresses
- › NMRA functions F1 through F24
- › Parallel and serial function triggering capability for compatibility with older equipment
- › Bi-directional communication with the Central Station
- › Split-screen display allows simultaneous control of two locomotives or a locomotive and an accessory
- › Multi-protocol capable: PIKO, Lenz Xpressnet and DiMAX
- › Multi-operator capable: Up to 8 Navigators can be used simultaneously with the Wireless Receiver (#35038)

INFO

Switch Decoder Technical Data 35013:

- › Operating voltage: 12-24 V NMRA/DCC (short-term max. 27V)
- › Total current capacity: 3 A
- › Switch machine outputs: 4 outputs at 1.5 A; maximum of two switch machines (#35271) per output (twin-solenoid or two wire bi-polar switch machines)
- › Addresses: 1 through 2047 (NMRA/DCC)
- › Dimensions: 95 x 64 x 23 mm (3.74" x 2.52" x 0.91")



35015

35015 Digital Booster

If you need more power than the 5 amp capacity of the Central Station, your layout can be divided into electrically separated „blocks“, with each additional block powered by a transformer (PIKO 35020) and a 35015 Digital Booster. Each Booster transmits the digital signal from the Central Station and provides power to its block. Trains pass seamlessly from one block to another. Up to 4 Boosters can be added, giving you a total layout capacity of up to 25 amps.

Input: 16-20 V DC, max. 5 A

Output: Up to 27 V DCC regulated, max. 5 A

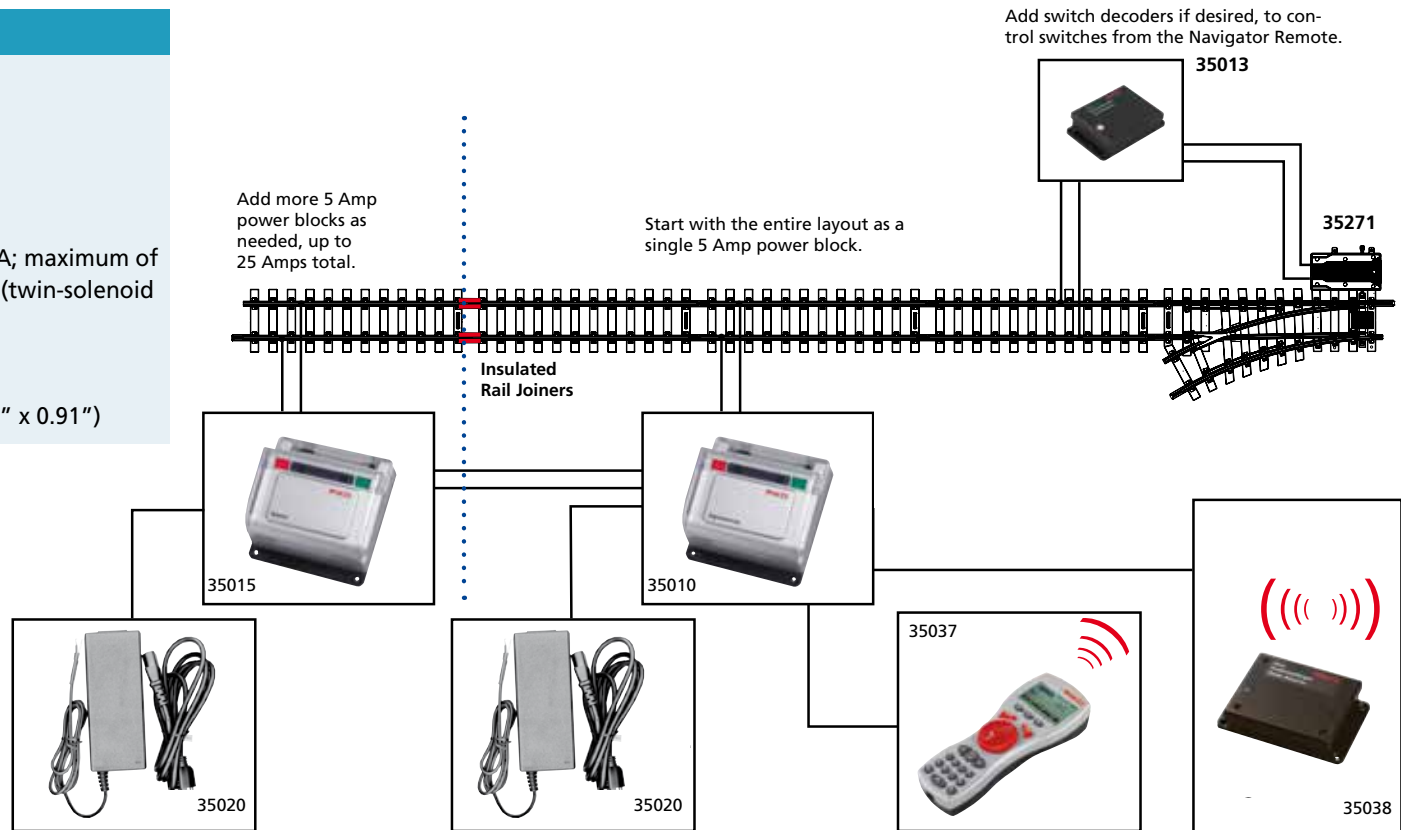

35013

35013 Switch Decoder

The splash-protected Switch Decoder allows for digital/DCC control of switch machines. A single decoder can operate up to four switch machines. The Switch Decoder is suitable for twin-solenoid type switch machines and two wire bi-polar switch machines (PIKO #35271). It can be controlled using a NMRA/DCC Digital Central Station (PIKO #35010).

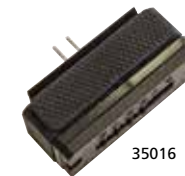

35016

35016 1-Channel Switch Decoder

Splash-protected switch decoder for operating a single electric switch machine (PIKO #35271). The decoder plugs directly into the switch machine's power terminals. It can be connected to a nearby track section using the PIKO Power Clamp (#35270). This eliminates long and complex wire runs.

Programing, Installing, & Testing are easy and clear

The new PIKO SmartProgrammer makes it easy to download your own sound files onto a decoder using a programming track or WLAN. With the Smart Decoder app for Windows PC, Android and iOS devices can have their digital parameters quickly configured without first having to attend a programmer's seminar. The PIKO SmartTester provides instant feedback on decoder settings using integral LEDs, a test motor, a speaker, or the appropriate App. It tests N, TT, and HO decoders as well as decoders from larger scales.

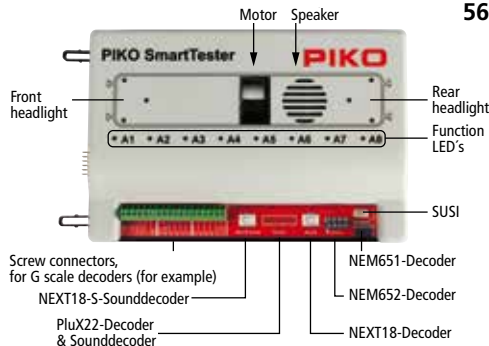

56416 PIKO SmartTester

- Quick and easy decoder function testing
- Instant feedback from activated functions via the integral speaker, motor, and LEDs for functions A1 to A8 as well as the front and rear headlights
- HO, TT, and N scale decoder receptacles as well as the potential to test larger scale decoders and SUSI interfaces
- Can be used in-tandem with the PIKO SmartProgrammer via a plug connection

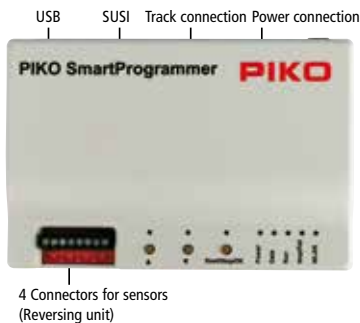

56415 PIKO SmartProgrammer

- Set digital parameters for your decoder
- Simple and Extended Function Mapping
- Transfer sound files via an integrated WLAN module or USB cable
- Easily upload decoder data via the programming track to the model
- Upload sound files quickly with the SUSI interface
- Upload your own sound files like station announcements, radio chatter, and more
- Trouble-free operation via free software for Windows PC as well as the app for iOS and Android devices
- Can be used as a "mini DCC system" for automatic train movements

PIKO SmartProgrammer App



The PIKO Digital System allows for simultaneous independent control of multiple locomotives on a track section. This requires the locomotives to be fitted with a digital decoder. All current PIKO locomotives are designed for easy installation of a PIKO locomotive decoder. Normally this entails a simple swap of the main circuit board for the appropriate PIKO locomotive decoder. Simply swap the main circuit board for the PIKO locomotive decoder and move the hookup wires from the screw terminals on the circuit board to the respective screw terminals on the decoder.

All PIKO SmartSound Decoder XP shown here offer the same features

- The main features are:**
- > For DC and bell armature motors rated up to 5 A
 - > 14, 28, and 128 speed steps depending on the DCC format
 - > 9999 digital locomotive addresses
 - > RailCom® and RailCom Plus®- compatible
 - > mfx®-compatible
 - > Corresponds to current RCN (European Digital Manufacturers Association) standards
 - > Generously sized energy capacitors
 - > Adjustable min., med., and max. speeds
 - > Adjustable extended motor speed curve
 - > Switching (shunting) gear mode
 - > 3 adjustable acceleration and braking delays, each switchable via F0 - F68
 - > Directional Rule 17 lighting
 - > 12 individual function outputs with 8x logic that are optionally directional-dependent
 - > 4 servo connections for model animation
 - > Light and function outputs adjustable for analog operation
 - > Optional secondary dimming setting for A0 to A12; switchable
 - > Simple function mapping for F0 - F12
 - > Extended function mapping for F0 - F68 for switching linked function outputs
 - > Locomotive lights facing the first car of the train can be switched off
 - > All function outputs have blinking options via four flash generators
 - > All function outputs can be triggered automatically via a variety of settings
 - > Load-dependent smoke generator
 - > Firebox light settings with adjustable parameters
 - > Automatic coupling/uncoupling and programmable switching scenarios
 - > Light and function outputs can be hidden
 - > Energy-efficient lamp effect
 - > Adjustable fluorescent lighting effect
 - > 8 PWM banks for North American train lighting effects like Mars Lights, Gyra Lights, Strobes, etc.
 - > SUSI socket for additional PIKO sound modules
 - > Braking with DCC brake signal, analog DC brake signal, or ABC brake signal including shuttle train operation
 - > Constant braking distance measured in cm
 - > Auto-adaptive motor control
 - > Motorola data format with 4 addresses for functions F1 - F12
 - > Conventional DC and AC analog operation
 - > Decoder size: 54 x 28 x 13 mm (2.1" x 1.1" x 0.5")
 - > Connector PCB size: 68 x 28.5 x 13 mm (2.7" x 1.1" x 0.5")
 - > Combined size: 68 x 28.5 x 16 mm (2.7" x 1.1" x 0.6")

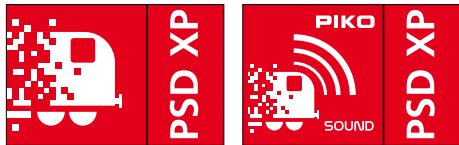

36500 SmartDecoder XP
 Features:
 • Dimensions: 54 x 28 x 13 mm

36511 XP Connector PCB with wire leads for G scale Taurus and BR 218
 Features:
 • Locomotive-specific wiring via the carrier board
 • Dimensions: 68 x 28,5 x 13 mm

36512 XP Connector PCB with wire leads for G scale BR 80
 Features:
 • Locomotive-specific wiring via the carrier board
 • Dimensions: 68 x 28,5 x 13 mm

36505 SmartSound Decoder XP Programmable
 Features:
 • Dimensions: 54 x 28 x 13 mm

36510 Connector PCB for G-PSD XP
 Features:
 • Dimensions: 68 x 28,5 x 13 mm

PIKO's latest digital decoder, the SmartDecoder XP (PSD XP for short), offers serious model railroaders a wealth of digital features. The PSD XP is fully compatible with the latest RCN (European DCC Manufacturers' Association) standards.

PSD XP with loud-speaker

Steam locos	Art.-Nr.	BR 118	36527
BR 24/ BR 64	36522	BR 132	36526
BR 50	36530	BR 199 / V 100	36540
BR 80	36537	BR 218	36535
BR 94	36521	V 36 / V 20	36524
BR 95	36528	V 60 / BR 260	36539
Electric locos	Art.-Nr.	NoHAB	36544
BR 103	36529	Railcars	Art.-Nr.
BR 194	36541	TEE VT 11.5 (two loud-speaker)	36543
Taurus	36534		
Diesel locos	Art.-Nr.	TEE Turbine BR 602 (two loud-speaker)	36523
BR 106	36533	VT98 Railbus	36536

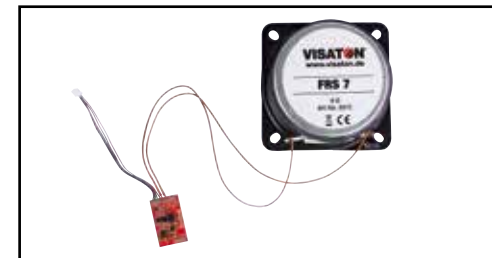

G-PSD XP Sound with loud-speaker

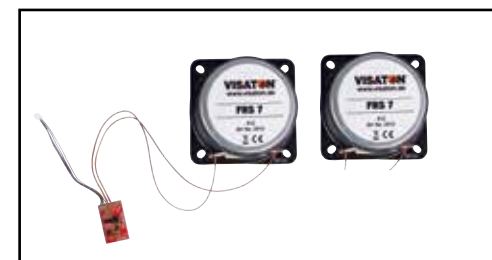

G-PSD XP Sound with two loud-speakers

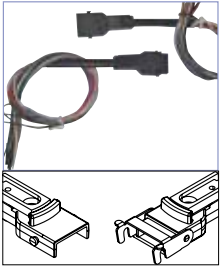

36032 12-Pole Electrical Plug Coupler, 1 Pr
Coupler with integrated 12-pole electrical connection. This coupler can replace the standard hook and loop coupler on most cars and locomotives. Among other things it can be used to power and control Interior Light throughout a train.

36033 Rigid Coupler Non-Electrical, 1 Pr
Same as 36032 without electrical contacts and cables

Mounting the Electrical Coupler example: Silver Coin Coach

1. Unscrew existing coupler and remove from truck.
2. Place new coupler holder on truck and screw down.
3. Route wires beneath axle and plug electric coupler head into holder.



36220 American Steam Sound Kit DC / DCC

This kit is ideal for the non-sound PIKO Mogul Steam Locos. It can also be adapted to many other steam locos. Simple screw-terminals for all connections ease installation. The heart of the kit is a state-of-the-art high-quality digital steam sound decoder developed exclusively for PIKO by SoundTraxx®. It provides full-featured operation on Analog DC as well as Digital DCC. The sound decoder provides outputs for front and rear lights, as well as a regulated 5V output for a smoke unit (#36142, not included). A small separate circuit board provides a manual sound volume control knob as well as an on/off switch for the smoke unit. The included reed switch sensor allows triggering of bell and whistle signals via track magnets (#35268, not included). The sound decoder can be configured using a DCC system to fit the desired characteristics of the loco. For example, one of three different whistle tones can be selected and the exhaust "chuff" rate can be set to closely match the rotation of the loco drive wheels. This programming remains in effect on Analog DC operation as well as DCC.



36221 American Steam Sound Kit, Analog

Provides economical analog steam sound for operation of DC layouts. Designed for easy installation in PIKO 0-6-0T locos, but can be adapted to other locos. Bell and whistle can be triggered by #35368 track magnets (not included).

36194 Analog-Sound Kit BR 80

Provides economical analog steam sound for operation of DC layouts. Designed for easy installation in PIKO 0-6-0T locos, but can be adapted to other locos. Bell and whistle can be triggered by #35368 track magnets (not included).

ITEM-NO. DESCRIPTION			ITEM-NO. DESCRIPTION			ITEM-NO. DESCRIPTION		
36000	Motor, 4 Wheel Gearbox Taurus, BR 218, V 100		36050	Arch Bar Freight Trucks, 1 pair		36113	Wheel Wipers right/left Schienenbus, Railbus	
36001	Motor, 6 Wheel Gearbox BR 80, US Steam Loco,		36051	Bettendorf Freight Trucks, 1 pair		36114	Pickup shoes, Railbus (Set of 2)	
36004	Motor w worm (1 thread) BR 194 w white or dark gears		36052	American Passenger Trucks, 1 pair		36115	Wheel Wipers right/left, V 60 / BR 260	
36005	Motor w worm (1 thread) Mogul w white or dark gears BR 80 / 0-6-0T w/Analog Sound, Old Mogul		36180	Idler gears (3 pcs.) Taurus, BR 218, V 100, V 199, Rail Bus, 25-Ton Diesel		36117	Pickup shoes, BR 194 (Set of 2)	
36006	BB Motor w worm Taurus, V100, BR 194 w red gears		36181	Idler gears (3 pcs.) BR 80, Old Mogul, 0-6-0, V 60 / BR 260		36118	Carbon brushes, BR 64/24 (Set of 8)	
36007	BB Motor w worm BR 80, Mogul, Camelback, TEE, V199 w/ Red Gears		36182	Idler Gear for BB BR 194 Motor 36006, 3 Pc Set		36142	Smoke Unit 5 V, for analog or digital, operate only with #36143 voltage regulator	
36008	BB Motor w gear Rail bus		36183	Idler Gear for BB Mogul Motor 36007, 3 Pc Set		36143	Voltage regulator 5 V for Smoke Unit #36142	
36009	BB Motor w worm V 60		36184	Idler Gear for BR 64 / BR 24 2 Pc Set		36150	Single-Arm Pantograph complete, Taurus	
36020	BB Motor w worm BR 24		36200	Engineer Figure		36151	Scissor Pantograph complete, BR 194	

ITEM-NO. DESCRIPTION			ITEM-NO. DESCRIPTION			ITEM-NO. DESCRIPTION		
36070	Traction Wheelset Taurus		36077	Hard-chrome plated Center wheelset BR 80, red		36084	BB plated wheelset BR 194, red	
36071	Traction Wheelset BR 218, V 100, V 199		36078	BB plated wheelset 0-6-0T, black, only for Gearbox 36107		36085	BB plated traction wheelset BR 194, red	
36072	Traction Wheelset Taurus Hard-chrome plated BB Traction Wheelset Taurus, only for Gearbox 36104		36079	Hard-chrome plated Center wheelset 0-6-0T, black		36160	Plastic Wheelset, 2 pcs	
36073	Wheelset Taurus Hard-chrome plated BB Wheelset Taurus, only for Gearbox 36104		36080	BB geared wheelset BR 194, black		36162	Plastic Wheelset, 3 pcs	
36074	Hard-chrome BB Traction Wheelset BR 218, V 100, V 199, only for Gearbox 36105		36081	BB plated traction wheelset BR 194, black		36164	Metal Wheelset, 30 mm, 2 pc Hard-chrome plated For all American cars	
36075	Hard-chrome plated BB Wheelset BR 218, V 100, V 199, only for Gearbox 36105		36082	BB plated wheelset BR 194, black		36165	Metal Wheelset, 35 mm, 2 pc Hard-chrome plated For many European cars	
36076	BB Geared Wheelset for BR 80, red Hard-chrome plated, only for Gearbox 36106		36083	BB plated traction wheelset BR 194, black		36166	Metal Wheelset, red, 30 mm, 2 pc Hard-chrome plated	

36091 Crankpins – Mogul Wheels
Set of 6 metal screw-type replacement crankpins. Nickel-plated screws. Fits large 45 mm (1.77") diameter "Mogul" loco wheels.



CAD drawing

36093 Crankpins – Starter Set Wheel:
Set of 6 metal screw-type replacement crankpins. Nickel-plated screws. Fits small 36.5 mm (1.44") diameter starter set, 0-6-0T and "Mini-Mogul" loco wheels.



CAD drawing

36094 Crankpins – BR80 Loco Wheels
Set of 6 metal screw-type replacement crankpins. Dark nickel-plated screws. Fits small 36.5 mm (1.44") diameter starter set BR80 loco wheels.



CAD drawing

ITEM-NO. DESCRIPTION			ITEM-NO. DESCRIPTION			ITEM-NO. DESCRIPTION		
36167	BB Metal Wheelsets w/ Pickups, 30 mm, 2 Pcs For all American cars		36175	Center Wheelset for 0-6-0T 0-6-0 & Mini-Mogul		36042	Traction Tires 4 pcs BR 64 3,2 x 44 mm	
36168	BB Metal Wheelsets w/ Pickups, 35 mm, 2 Pcs For many European cars		36176	Wheel set w gear V 60 / BR 260		36044	Traction Tires 4 pcs GE 25-Ton 3,2 x 30 mm	
36170	Geared Wheelset Taurus		36177	Traction Wheelset V 60 / BR 260		36030	Standard Coupler 1 Pc complete	
36171	Geared Wheelset BR 218, V 100, V 199, Rail Bus		36178	BB Geared Wheelset Hard-chrome plated BR 194		36090	Set of screws (20 pcs.)	
36172	Geared Wheelset BR 80		36179	BB Traction Wheelset Hard-chrome plated BR 194		36110	Standard Pickup shoes (Set of 2) Taurus, BR 218, BR 80, Mogul, 0-6-0, Camelback, V100/199	
36173	Idler Wheelset BR 80		36040	Traction Tires 4 pcs V 60 / BR 260, Mogul 34 x 41 mm		36111	Wheel Wipers right/left Taurus, BR 218, V 100	
36174	Geared Wheelset 0-6-0 & Mini-Mogul		36041	Traction Tires 4 pcs BR 218, V 100, V 199 28 x 34 mm		36112	Wheel Wipers right/left Mogul, 0-6-0, Camelback, V199	

36145 Pantograph Servo Motor
one for each pantograph
(max. 2 servo motors) to
control with decoder PIKO
SmartDecoder 4.1 G #36125



36320 Extra weight, 2 pieces









35267 Reed Switch Assembly
For triggering bell and
whistle functions on most
PIKO sound units, via
#35268 Track Magnets.

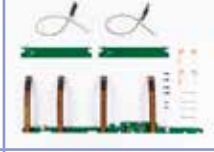

ITEM-NO.	DESCRIPTION	
36130	Interior Light Rail Bus	
36131	Interior Light Umbau Cars	
36132	Interior Light Silver Coin Cars	
36133	Interior Light VT 11.5 VT 11.5 End Car	
36134	Interior Light VT 11.5 VT 11.5 Middle Car	
36135	Interior Light US Passenger Car	
36136	Interior Light US Wood Drover's Caboose	
36137	Interior Light Reko Coach	

ITEM-NO.	DESCRIPTION	
36138	Interior Light Reko Combine	
36139	Interior Light Silver Coin Control Car	
36250	Interior and Marker Light Kit, Work Caboose	
36012	Wired LED BR 218	
36013	Wired LED BR 80, US Steam Loco 0-6-0	
36014	LED Lighting Set, 6 LEDs V 60 / BR 260	
36015	Replacement Light Set - 6 LEDs V 100, V 199	
36016	Add-On Rear Light Set - 4 LEDs V 100, V 199, BR 218	

ITEM-NO.	DESCRIPTION	
36017	Interior Light for drivers cab and Engine bay	
36018	Interior & Marker Light, Pwg88 Baggage Car	
36019	Interior Light, Railjet/IC Control Car	
36104	BB Motor Block complete, Taurus	
36105	BB Motor Block complete BR 218, V 100	
36106	BB Motor Block complete BR 80, red	
36107	BB Motor Block, 0-6-0T & Mini-Mogul	
36108	BB Retrofit Motor Block BR 194, with BB motor and revised gear ratios	
36109	BB Motor Block, New Style Complete, Mogul	



35421 Mini-Hacksaw
With low-wear metal-cutting blade. Ideal for cutting PIKO G track rails.



36039 Uncoupling Wand
For easy uncoupling of standard hook-and-loop couplers on most G-Scale trains



36215 Conductive Paste, 50 ml



36216 Gear Grease, 50 ml



35420 Set Screwdriver, 4 Pcs.
High-precision, suitable for PIKO G items. Contains 2 Phillips, no. 0 and 1 and 2 Flat Blade Screwdrivers 2,5 mm and 4 mm.



36210 Smoke & Cleaning Fluid, 250 ml



35412 Track Cleaning Pads, 10 Pcs., 140 mm x 100



35413 Track Polishing Pads, 2 Pcs., 140 mm x 100 mm



56301 Oil for Locos, 50ml



35411 Track Cleaning Set
Contents:
1 Track Cleaning Block
5 Track Cleaning Pads
100 ml Track Cleaning Fluid



35414 Track Cleaning Fluid, 250 ml



38506 Clean Machine R/C operation, completely battery-powered



See page 36 for more info



35416 Track Cleaning Shoes, Clean Machine, 2 sets



37720 Track Cleaning Car, 2 Track Cleaning Pads and 100 ml Cleaning Fluid included



MODEL BUILDINGS

- > Realistic detailing
- > Accurate fit
 - > Realistic coloring
 - > Parts molded in multiple appropriate colors – no painting needed
 - > Easy assembly
 - > Weathered parts on many buildings
 - > Comprehensive, easy to understand instructions





62040 "Rosenbach" Station

With its rural architecture, pleasant warm colors, pretty window shutters and benches under the little awning, this station recalls a genuine piece of railroading romance thought to have been lost for ever. We recommend the baseplates #62005 to enhance the model (1 set).

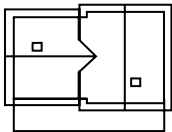

370 x 240 x 240 mm
14.6 x 9.4 x 9.4 "



62041 "Rosenbach" Switch Tower

The control-room with windows in every direction houses the lever frames that operate the switches and signals. Typical of this type of tower is the filigreed outside staircase and handrail. We recommend the baseplates #62005 to enhance the model (1 set).

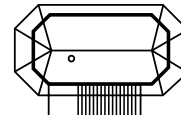

260 x 200 x 410 mm
10.2 x 7.9 x 16.1 "



62033 "Rosenbach" Signal Bridge

In order to provide the engineer with an unobstructed view of the signals, many railroads used special signal bridges. The steel bridge is weathered and carries two adjustable semaphore type signals.

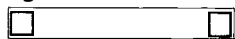

55 x 485 x 300 mm
2.2 x 19.1 x 11.8 "

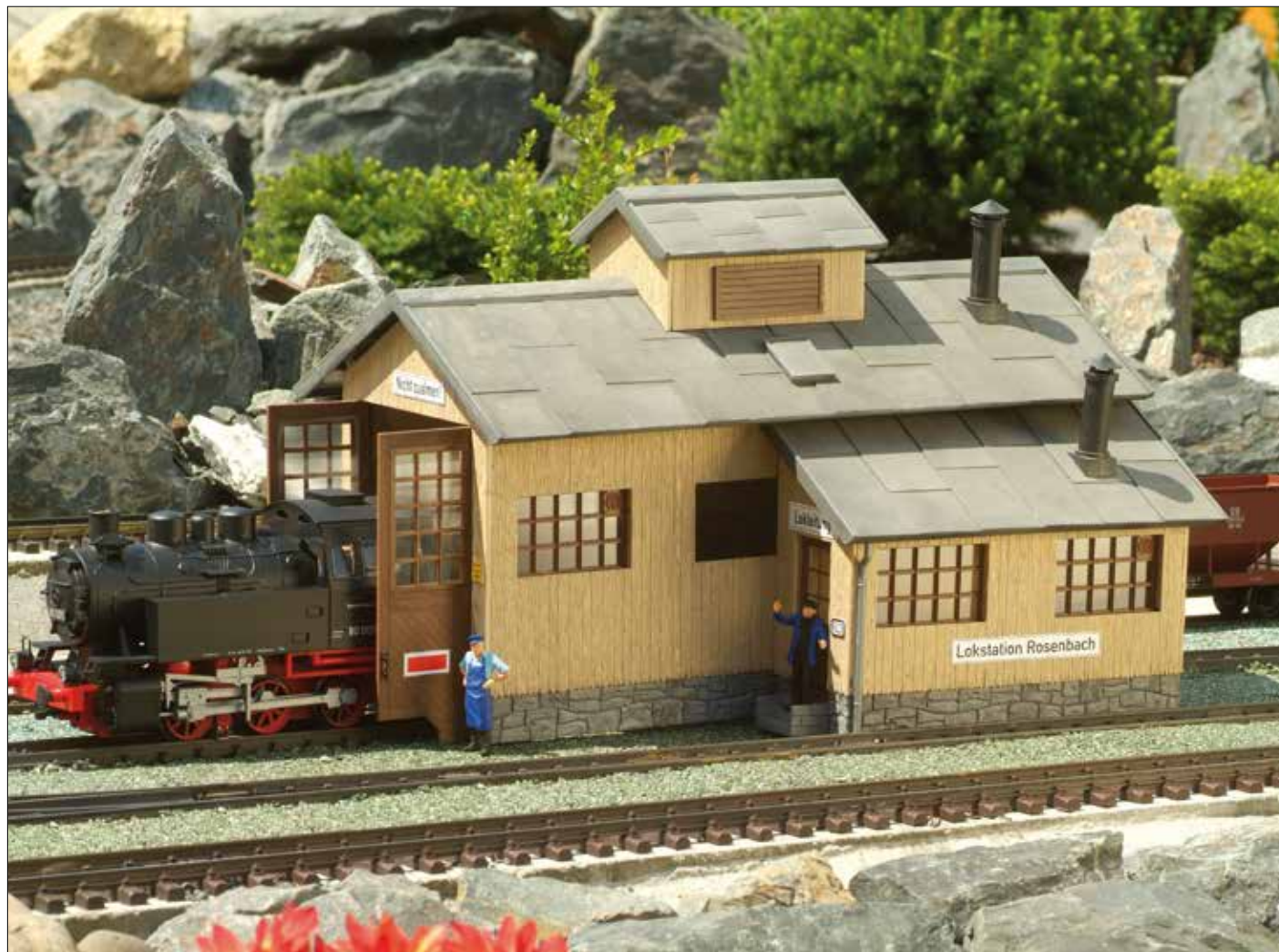

62042 "Rosenbach" Engine Shed

The shed has large double doors and a roof with a louvred superstructure for ventilation. The annex houses the local engine dispatcher's office. Doors can be opened and closed.

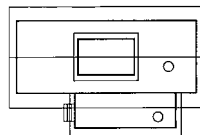

290 x 500 x 350 mm
11.4 x 19.7 x 13.8 "

62029 Blue Creek Valley Station

The cozy station provides a welcome retreat from the weather for passengers awaiting for the next train. The building is realistically weathered and has opening doors.

We recommend the baseplates #62005 to enhance the model (1 set).

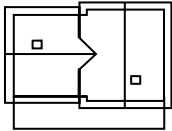

370 x 240 x 240 mm
14.6 x 9.4 x 9.4 "



62008 Sonneberg Goods Depot

Wooden ramps on both sides of the building aide the loading and unloading of freight cars. At the frontside is a fully operational roll-up door while a wooden door on the back allows for handling larger goods.

We recommend the baseplates #62005 to enhance the model (1 set).

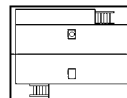

390 x 526 x 370 mm
18.9 x 20.7 x 14.6 "



62030 Neustadt Station

① The station has many distinctive features: decorative brickwork at the corners, large decorated pillars in the entrance area, a hipped roof and an awning with wrought iron detailing. The doors can be opened and closed. We recommend the set of baseplates #62005 to enhance the model (1 set).

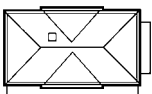

550 x 355 x 400 mm
21.6 x 14.0 x 15.7 "

62004 Covered Platform

② The platform is weather-resistant and can be placed alongside the track or between adjacent tracks. That way a station can have two or more parallel tracks with platforms.

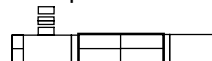

550 x 355 x 400 mm
21.6 x 14.0 x 15.7 "



62005 Baseplates with Cobbled surface

The set consists of two baseplates that provide a stable foundation for PIKO model buildings.

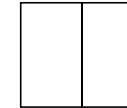

One plate:
460 x 267 x 10 mm
18.1 x 10.5 x 0,4 "



62006 Platform Sections with Cobbled surface

The crossing section kit is an ideal weather-resistant addition to the Covered Platform #62004 and "Neustadt" station #62030. (tracks not included)

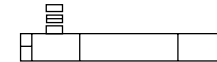

1138 x 174 x 10 mm
44.5 x 6.9 x 0.4 "



62074 Streitberg Passenger Shelter

Located in the Wiesent Valley in Frankonian Switzerland the Streitberg passenger shelter protects passengers from the hot sun or pouring rain. The kit is equipped with opening doors. Benches as well as picnic tables are included.

We recommend the baseplates #62005 to enhance the model (1 set).



250 x 340 x 150 mm
9.8 x 13.4 x 5.9



62032 "Neustadt" Railway Footbridge

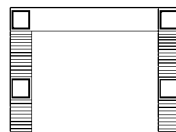

485 x 360 x 300 mm
19.7 x 14.8 x 11.8 "



62075 Diesel Locomotive Filling Station

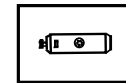

270 x 175 x 110 mm
10.6 x 6.9 x 4.3 "



62076 Coaling Station

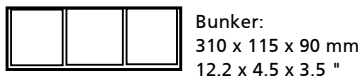
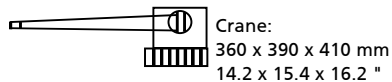

62113 Utility Buildings

The kit includes two weathered utility buildings with opening doors.

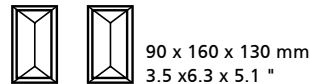

62296 Load - Crates & Pallets

The kit includes 4 crates, 4 pallets and several long and short pieces of lumber.



62232 Track Inspection Shed

In order to provide track inspection cars with shelter, many railroad companies built small sheds. The old fashioned roof, planked walls, double doors and the small side entrance have been weathered. The gate opens and closes automatically.

Note: Kit includes a corrugated metal-style roof instead of a shingled roof.

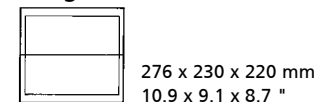

62209 "Grizzly Flats" Station

The American Victorian style station is typical for the time around 1870. The doors and windows can be opened and closed. We recommend the baseplates #62005 to enhance the model (1 set).

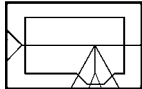

485 x 310 x 290 mm
19.1 x 12.2 x 11.4 "



#62209 Rear View "Grizzly Flats" Station

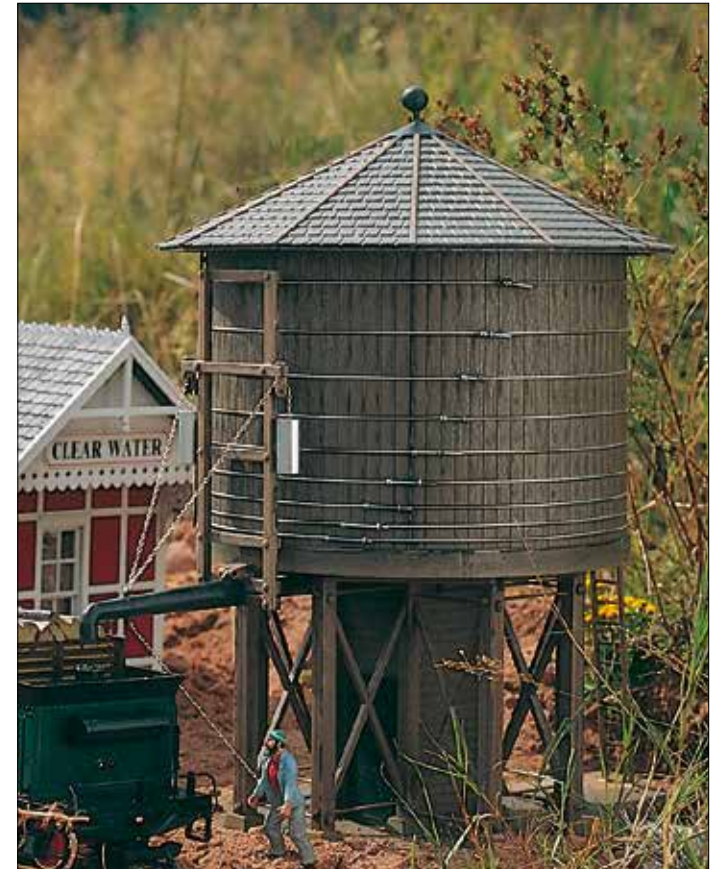
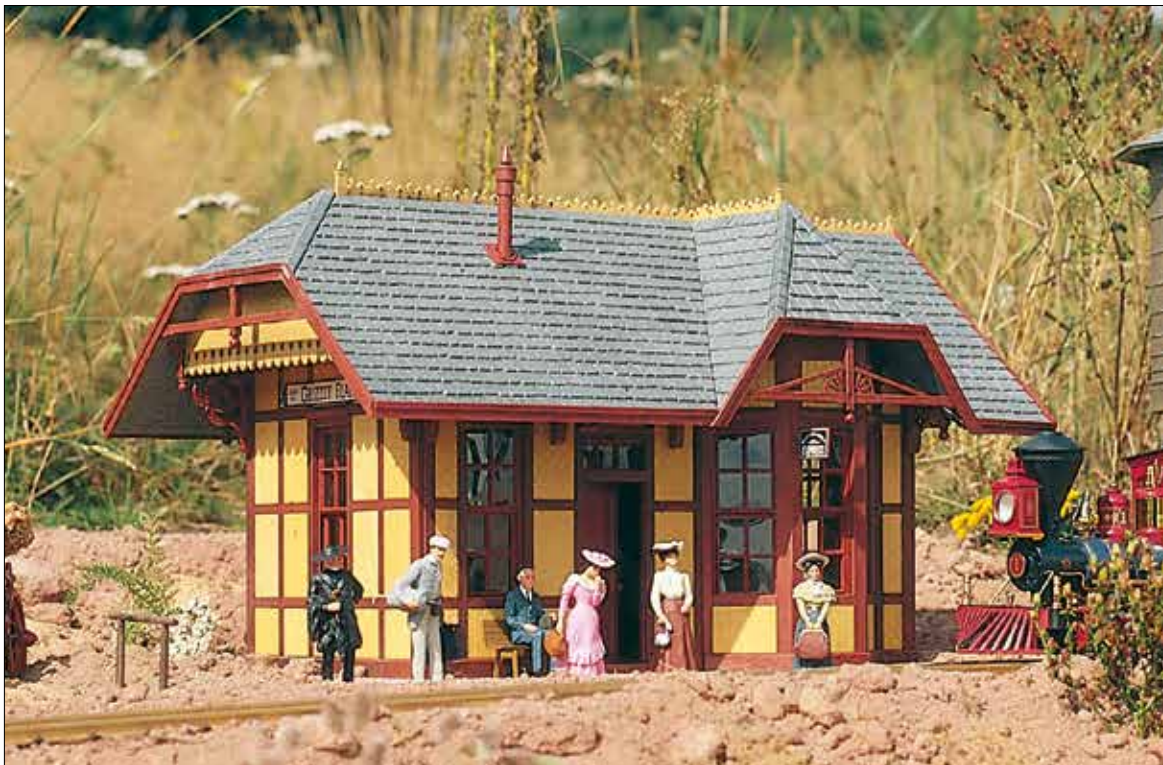

62210 "Rio Grande" Water Tower

The artificially aged and weather-resistant kit is an original reproduction of a 50,000 gallon tank used by the Rio Grande Southern in Rico, CO. It is the prototype for all RGS & Denver & Rio Grande water tanks. The tank can be filled with water and emptied via the spout. Baseplate included.

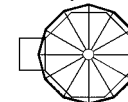

252 x 335 x 450 mm
9.9 x 13.2 x 17.7 "



62230 "Clear Water" Station

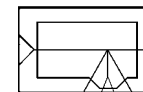

485 x 310 x 290 mm
19.1 x 12.2 x 11.4 "

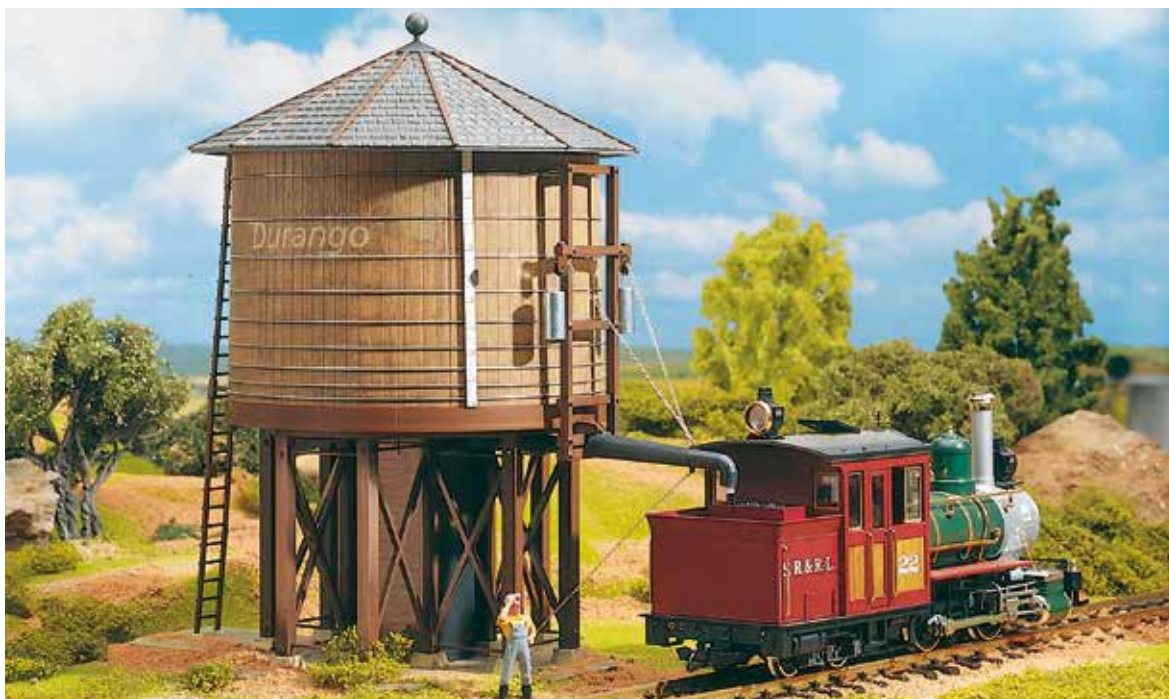

62231 "Durango" Water Tower

The tank can be filled with water and emptied via the spout. Baseplate included.

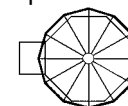

252 x 335 x 450 mm
9.9 x 13.2 x 17.7 "

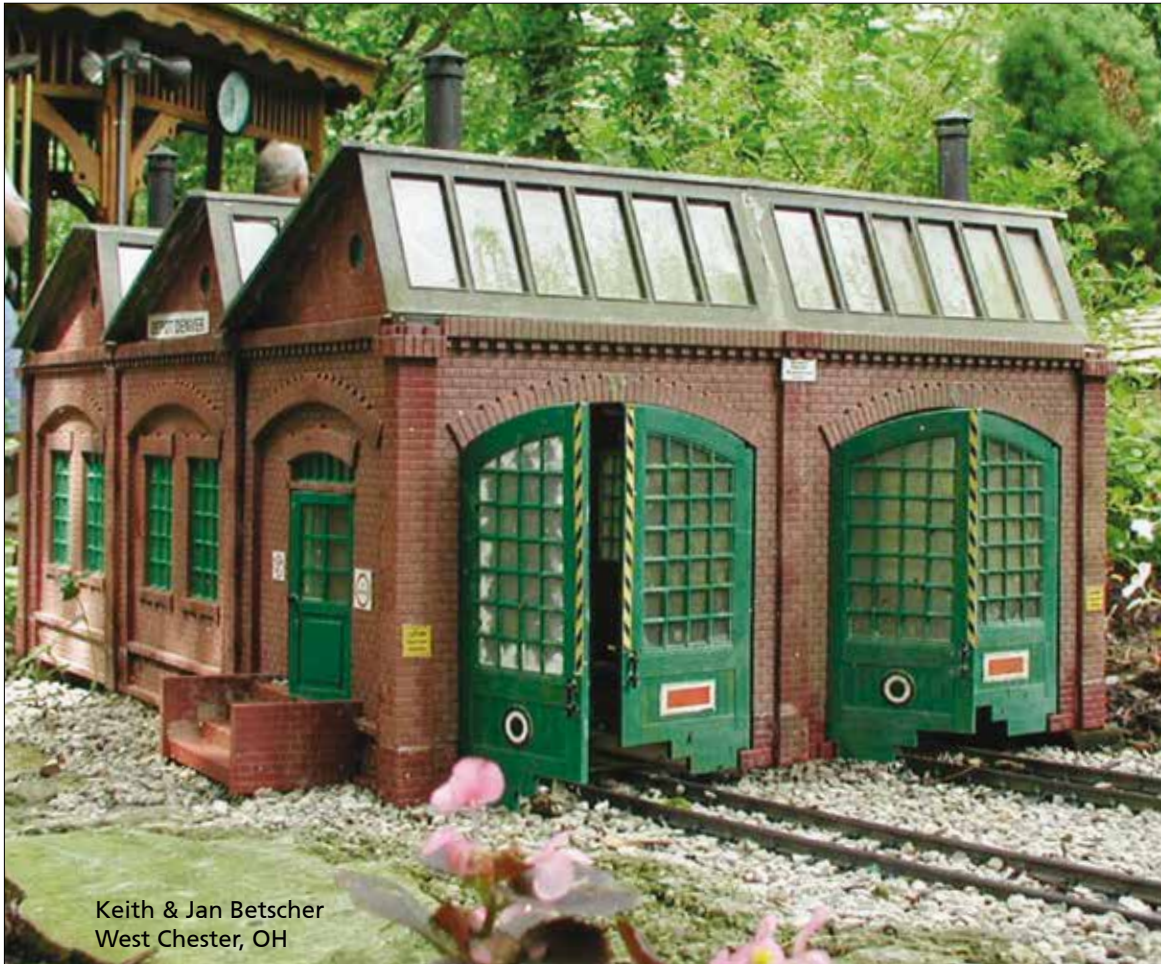

Keith & Jan Betscher
West Chester, OH

62001 "Sonneberg" Loco Shed

With the PIKO automatic door closer, #62002 the doors can be opened and closed automatically by a locomotive moving in or out. The shed accommodates locomotives of up to 25.6" in length. The realistically aged and weather-resistant building can be extended in length as well as in width by adding extension kits.

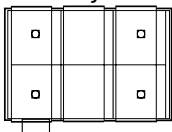

526 x 705 x 370 mm
20.7 x 27.8 x 14.6 "
Track Centers 230 mm



62007 Loco Shed Extension Set

With this extension set the Sonneberg Loco Shed, #62001, can be extended by 9.1" (23cm). The set contains all necessary parts as well as the proper extension for the Automatic Door Closer, # 62002.
230 x 526 x 370 mm
9.1 x 20.7 x 14.6 "

62002 Automatic Door Closer

Once the Automatic Door Closer is added to the Sonneberg Loco Shed #62001 the doors will be opened and closed automatically by a locomotive moving in or out. Due to its modular design the Automatic Door Closer can be used with extended loco sheds.

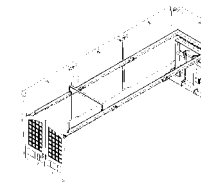

1138 x 174 x 10 mm
44.5 x 6.9 x 0.4 "



62056 Schwarz's Coal Supply

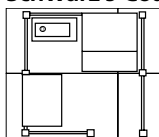

634 x 534 x 220 mm
24.9 x 21.0 x 9.1 "



62261 Log Cabins

Two small log cabins with opening doors.

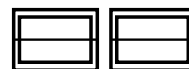

90 x 130 x 120 mm
3.6 x 5.1 x 4.7 "



62044 Red River Loco-shed

Engine shed with two-wing door. Doors open and close automatically as the locomotive enters or leaves.

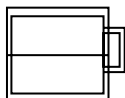

316 x 230 x 220 mm
12.4 x 9.1 x 8.7 "



62077 Loading Crane

Small hand-operated loading crane. The kit includes several crates and pallets.

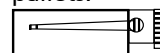

335 x 145 x 60 mm
13.2 x 5.7 x 2.4 "



62059 St. Ursula Church

The lovely St. Ursula's church is scenically situated in the cozy Fex Valley of Switzerland. The interior is adorned with marvelous 16th century frescoes. The model comes complete with a bell and an opening front door.

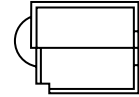

300 x 200 x 350 mm
11.8 x 7.9 x 13.8 "



62109 Saint Bonifaz Chapel

This beautiful little chapel overlooks the town. The bell rings at regular intervals to welcome the townspeople through the model's opening doors. We recommend the set of baseplates #62005 to enhance the model further (1 set).

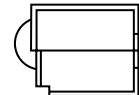

300 x 200 x 350 mm
11.8 x 7.9 x 13.8 "



62228 "Red River" Station

This realistically weathered building can be easily disassembled and is equipped with opening doors. We recommend the set of baseplates #62005 to enhance the model (1set).

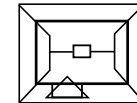

215 x 175 x 205 mm
8.5 x 6.9 x 8.1 "



62021 "Fred's" Snack Bar

The kiosk is realistically weathered and weather proof. Various accessories such as flags and newspaper stands are included to complement the kiosk. We recommend the baseplates #62005 to enhance the model (1 set).

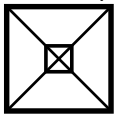

150 x 150 x 170 mm
4.9 x 4.9 x 5.9 "



62043 "Tiefenbach" Station

Somewhat off the beaten path but still close by is the station "Tiefenbach". With its pleasant warm colors and attractive shutters, the station adds a touch of romance to the garden railway. In addition to the ticket hall, the three-part building houses a busy station restaurant. The doors can be opened and closed. To complete the set we recommend the baseplates #62005 (2 sets).

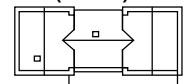

610 x 240 x 240 mm
24.0 x 9.4 x 9.4 "



62285 Set of 5 Garden seats

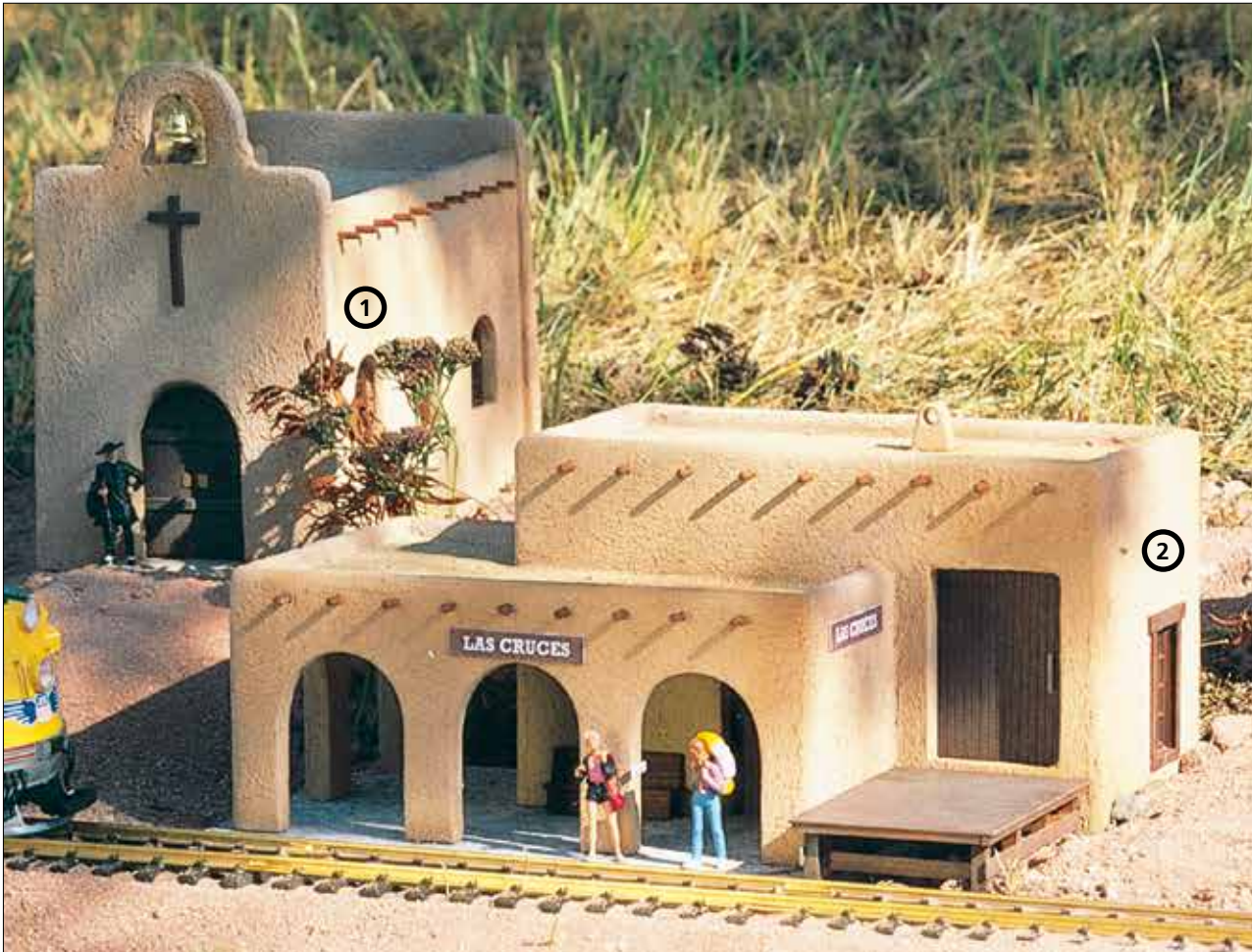

The Southwest Series offers a number of typical Southwest adobe-style buildings. Earth tone colors fit well with the sun-drenched landscape. A characteristic feature of these buildings are the exposed ends of the round wooden beams that support the flat roof.

62254 Las Cruces Town Building

③

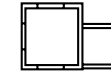

290 x 200 x 180 mm
11.4 x 7.9 x 7.1 "

62253 Las Cruces Church

①

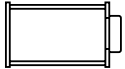

390 x 220 x 330 mm
15.3 x 8.7 x 13.0 "

62252 Las Cruces Train Station

②

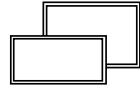

490 x 310 x 240 mm
19.3 x 12.2 x 9.4 "

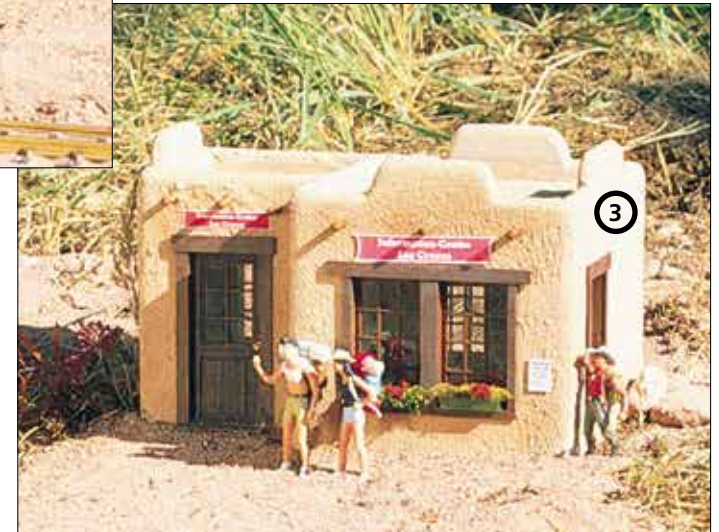

③



62106 Santa Fe Medical Center

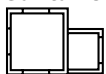

290 x 200 x 180 mm
11.4 x 7.9 x 7.1 "



62105 Santa Fe Station



490 x 310 x 240 mm
19.3 x 12.2 x 9.4 "



62108 Mission San Antonio

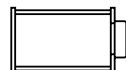

390 x 220 x 330 mm
15.3 x 8.7 x 13.0 "



62014 Brewery Main Section

① You can create a unique brewery complex by combining multiple kits or by adding side buildings. The building sections are weather-resistant and realistically aged. The gate at the main entrance can be opened and closed.

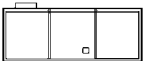

704 x 280 x 500 mm
27.7 x 11.0 x 19.7 "



62289 Factory Gate

② Our big factory gate with its iron doors fits perfectly to the Factory Walls (#62288) and creates an attractive entrance to each industrial setting.

 240 x 42 x 220 mm
10.9 x 9.1 x 8.7 "

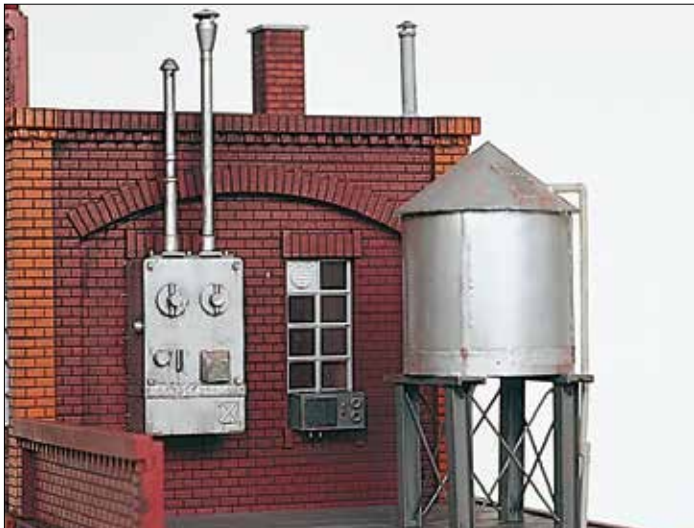

62013 Brewery Equipment

⑦ This accessory kit consists of an airconditioning unit, a ventilation unit and a large tank that stores water for the brewery's sprinkler system. The water tank is a common sight in America.



62015 Brewery Sidebuilding

③ The distinctly shaped roof with the sloping roof windows makes this building particularly interesting. The front gates of this weather-resistant, realistically aged model open.

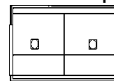

480 x 250 x 297 mm
18.9 x 9.9 x 11.7 "

62016 Chimney

⑤ The matching chimney for our brewery complex takes its stability from its solid base. The chimney itself stands 28.7" tall. A billboard can be attached to the outside.



160 x 160 x 730 mm
6.3 x 6.3 x 28.7

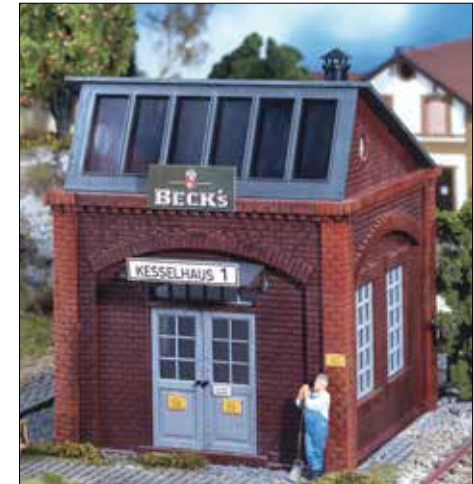

62017 Boilerhouse

④ The boilerhouse with its shed roof and opening door can also be used as a machine shop or warehouse. Due to its modular construction the building can be extended as needed.



250 x 280 x 297 mm
9.8 x 11.0 x 11.7 "

62288 Brick Factory Walls

⑥ Industrial complexes are often surrounded by brick walls. The enclosed walls and pillars have an overall length of 41.1". They are an excellent fit for PIKO®'s Brewery #62014 or many other industrial buildings. They can be used with the #62289 factory gate.

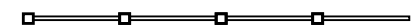

105 x 3,3 x 8,7 cm
41.1 x 1.3 x 3.4 "



62290 Industrial Fence

④ Two sets #62290 are required for completely fencing the depot.

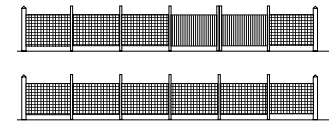

Content: 1 gate, pales, app. 4.6 ft. fence

62038 Tank (high)

① Tank, hoch / high:
ř 315 mm
370 mm hoch / high
ř 12.4" x 14.6"

62039 Tank (low)

② Tank, niedrig / low:
ř 315 mm
270 mm hoch / high
ř 12.4" x 10.6"

62037 Depot Office

③  240 x 230 x 200 mm
9.5 x 9.0 x 7.9 "

The two diesel tanks are fitted with a railing on top, a fixed ladder to reach the top and a fill pipe. "Exxon" and "Esso" stickers for branding the depot are included in the kit. If necessary the tanks can be put on #62005 baseplates.

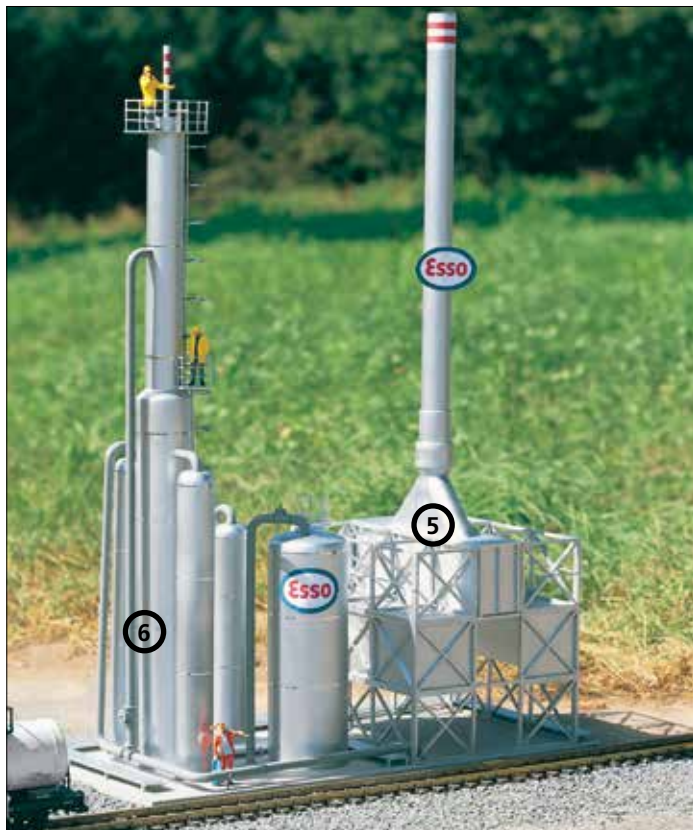

62046 Refinery Burn-Off Plant

⑤

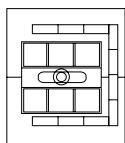

460 x 534 x 1060 mm
18.1 x 21.0 x 41.7 "



62049 Refinery Loading Dock

⑦

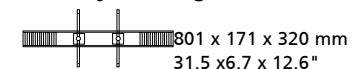

62047 Refinery Cracking Plant

⑥

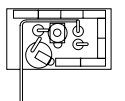

460 x 267 x 1010 mm
18.1 x 10.5 x 39.8 "



62048 Refinery Storage Tanks

⑧

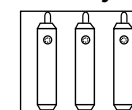

3 tanks included.
267 x 348 x 90 mm
10.5 x 13.7 x 3.6"
1 tank:
250 x 52 x 80 mm
9.8 x 2.0 x 3.2 "

62019 Mr. Mann's Can Factory

The weather-resistant and realistically aged building is modeled after early 20th century industrial buildings. The doors on this kit can be opened and closed. Thanks to the kit's modular design, several kits can be combined to create an even larger factory building. The factory's exterior color makes it the perfect fit for the Power Substation #62018. The water reservoir and air conditioning unit shown here are from kit #62013 and are not included. We recommend the baseplates #62005 to enhance the model (1 set).

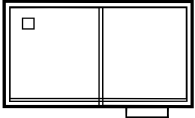

470 x 280 x 500 mm
18.6 x 11.0 x 19.7 "

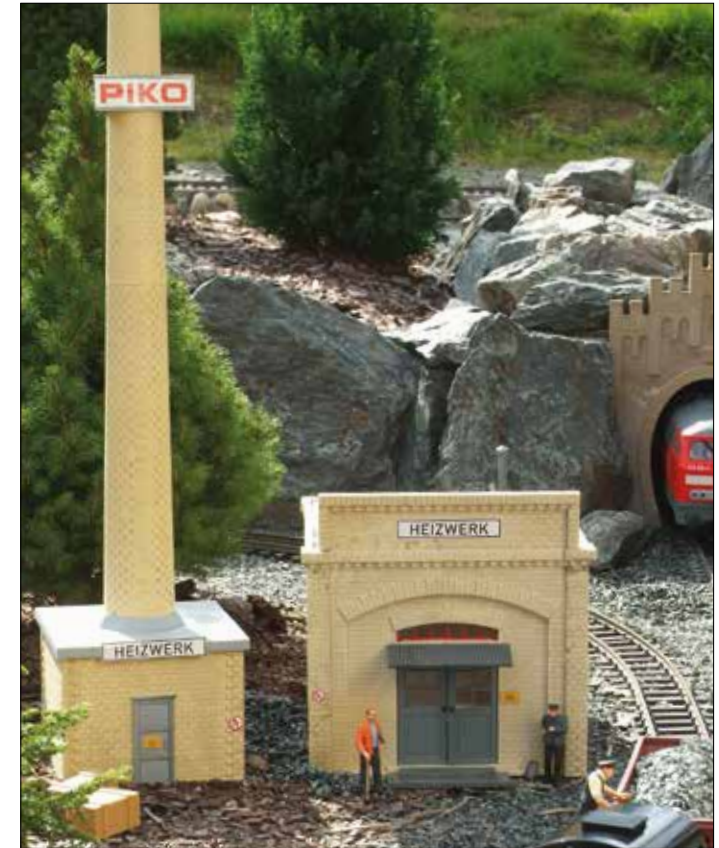
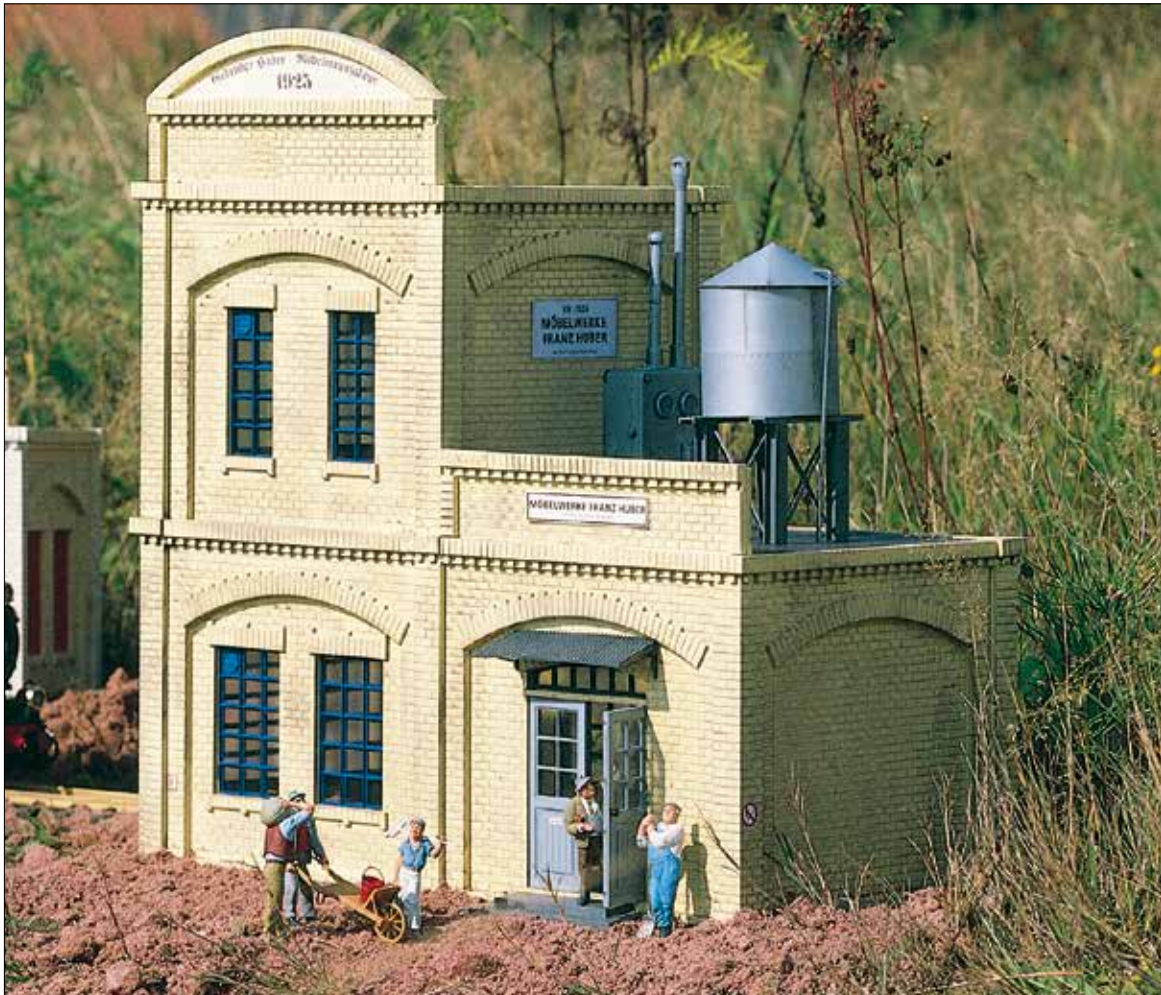

62018 Power Substation



Chimney: 6.3 x 6.3 x 28.7 "

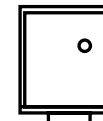

Power Station: 9.8 x 11.0 x 11.7 "



62011 Automatic Loader for Gravel Works

- ① Place the gravel in the main building's #62009 gravel container. From there it can be loaded into railcars by using the motor driven automatic loading unit. (not visible in this photo)

62009 Gravel Works Main Building

- ③ The gravel work's main building stands on a masonry base with windows. The loading and unloading can be monitored from the small annex. The main building can be extended with the Side Building #62010, and the Automatic Loader #62011, to enable realistic operation.

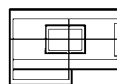

500 x 200 x 515 mm
19.7 x 7.9 x 20.3 "

62010 Gravel Works Side Building

- ② This addition simulates a housing for a conveyer to lift gravel up to the main building.

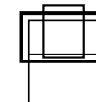

225 x 270 x 370 mm
8.8 x 10.6 x 14.6 "



62034 Co-Op Warehouse

- ① The building can be set up on its own or in conjunction with the storage tower #62035. We recommend the baseplates #62005 to enhance the model (1 set).

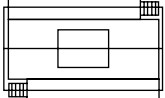

526 x 280 x 330 mm
20.7 x 11.1 x 13.0 "

62035 BayWa Storage tower

- ② Besides the "BayWa" decals the kit includes decals to create a "Raiffeisen" building. The building can be set up on its own or in conjunction with the warehouse #62034. We recommend the set of baseplates #62005 to enhance the model (1 set).

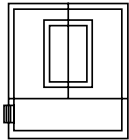

360 x 310 x 800 mm
14.2 x 12.2 x 31.5 "





62036 Co-Op Silo

The kit contains one silo and the necessary piping.

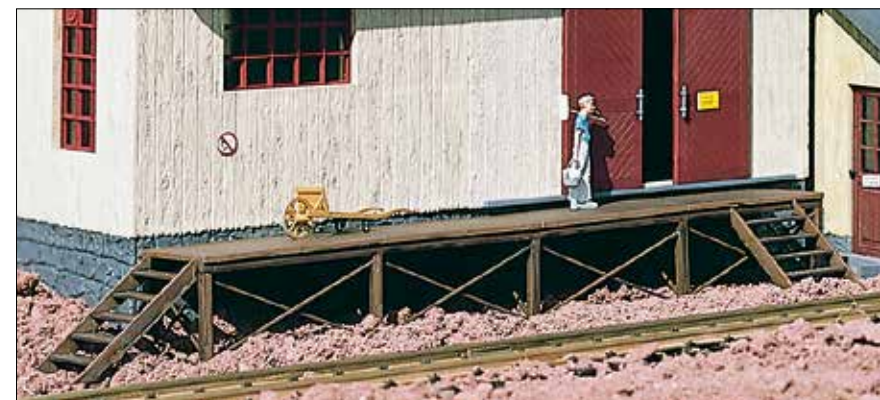
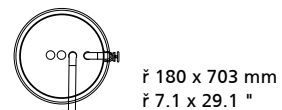

62287 Loading Dock for Goods Shed

2 sets of stairs and 4 platform sections.

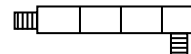

515 x 145 x 60 mm
20.3 x 5.7 x 2.4 "



62064 Gramss Baker's Shop

①

62065 Bauer's Florist's Shop

②

62066 Dr. Lang's Practice

③

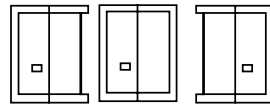

Size for:
#62064, #62065, #62066:
160 x 210 x 285 mm
6.3 x 8.3 x 11.2 "

Size for:
#62067, #62068:
160 x 210 x 320 mm
6.3 x 8.3 x 12.6 "



62068 Gunilla's Hair Salon

④

62067 Sunny Pharmacy

⑤



Garden Town Series

The buildings in the Garden Town Series with their lovingly designed details can be used either as single units or in conjunction with each other to create the idyllic atmosphere of a small town or a particular street. With the exception of a few individual parts the buildings can be assembled without glue.



62057 Beate's Pottery

This lovingly detailed home is accompanied by a market stand stocked with pieces of pottery. The front door can be opened and closed. We recommend the set of baseplates #62005 to enhance the model (1 set).



240 x 290 x 250 mm
9.4 x 11.4 x 9.8 "



62053 Frank's Timbered House

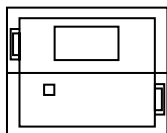

360 x 290 x 345 mm
14.2 x 11.4 x 13.6 "



62050 Dr. König's House

Dr. König and his family live in this little half-timbered home with hipped roof. Many accessories such as flower boxes and the newspaper holder, as well as the detailing on the building, make this home a showpiece for any layout. The front door can be opened.

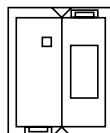

360 x 290 x 345 mm
14.2 x 11.4 x 13.6 "

We recommend the set of baseplates #62005 to enhance the model (1 set).



62051 Rosenbach Watermill

Decorative timberwork and a hipped roof make the old watermill with its fully operational water wheel an idyllic sight on your garden layout. The building has two opening doors and many accessories such as window boxes and a newspaper holder as well as many other details. The water wheel can be motor-driven. We recommend the Water Wheel Motor #62052.

326 x 345 x 370 mm
12.8 x 13.6 x 14.6 "

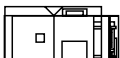

62052 Water Wheel Motor

In case the water wheel on your layout cannot be driven by running water, this robust electric motor can drive the water wheel. The kit includes the motor itself as well as all necessary parts for its installation.



62022 Beer Garden Café

With its bright attractive colors, pretty flower boxes, maypole, tables, and benches in the idyllic garden, the Beer Garden Cafe invites customers to linger. A scene which forms a romantic feature on any layout. The doors of the weather-resistant and partially aged model open. Benches and picnic tables are included in this kit.

We recommend the set of baseplates #62005 to enhance the model (1 set).

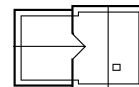

370 x 240 x 240 mm
14.6 x 9.4 x 9.4 "

62282 Beer Garden Tables and Benches

This kit can be used to extend the beer garden of the "Beer Garden Café" #62022 or any other garden as desired. The kit includes three tables, six benches and three garden seats.



62072 House under construction

Some of the walls have already been repainted as can be seen by the difference in color. The weather resistant kit includes scaffolding and fence sections. The doors can be opened and closed.

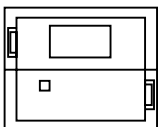

360 x 290 x 345 mm
14.2 x 11.4 x 13.6 "

We recommend the set of baseplates #62005 to enhance the model (1 set).



62073 Brenda's Brick House

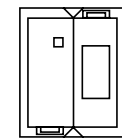

360 x 290 x 345 mm
14.2 x 11.4 x 13.6 "



62058 Old Mill

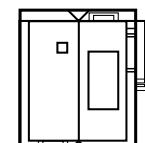

326 x 345 x 370 mm
12.8 x 13.6 x 14.6 "

Water mill motor #62052 on page 148



62117 Fresh Produce Stand

①

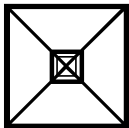

150 x 150 x 182 mm
4.9 x 4.9 x 7.4 "

62118 Sausage Shop

②

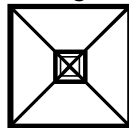

150 x 150 x 182 mm
4.9 x 4.9 x 7.4 "

62119 Cheese Shop

③

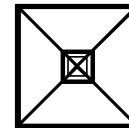

150 x 150 x 182 mm
4.9 x 4.9 x 7.4 "

The weekly farmers market has a number of small booths where people buy produce and other groceries. (Figures and accessories not included.)
The doors of the weathered booths can be opened and closed.



62293 Work Shop Accessory Set



62294 Softdrink Crates



62284 Old-fashioned Petrol Pump, Yellow (Not Shown)
The ready-made kit includes a radiator water can, tire racks and replacement tires.



62286 Antique Gasoline Pump "Texaco"
① Addition to #62264. The ready-made kit includes a radiator water can, tire racks and replacement tires.

62264 "Texaco" Gas Station

②



210 x 280 x 220 mm
11.2 x 8.3 x 8.7 "

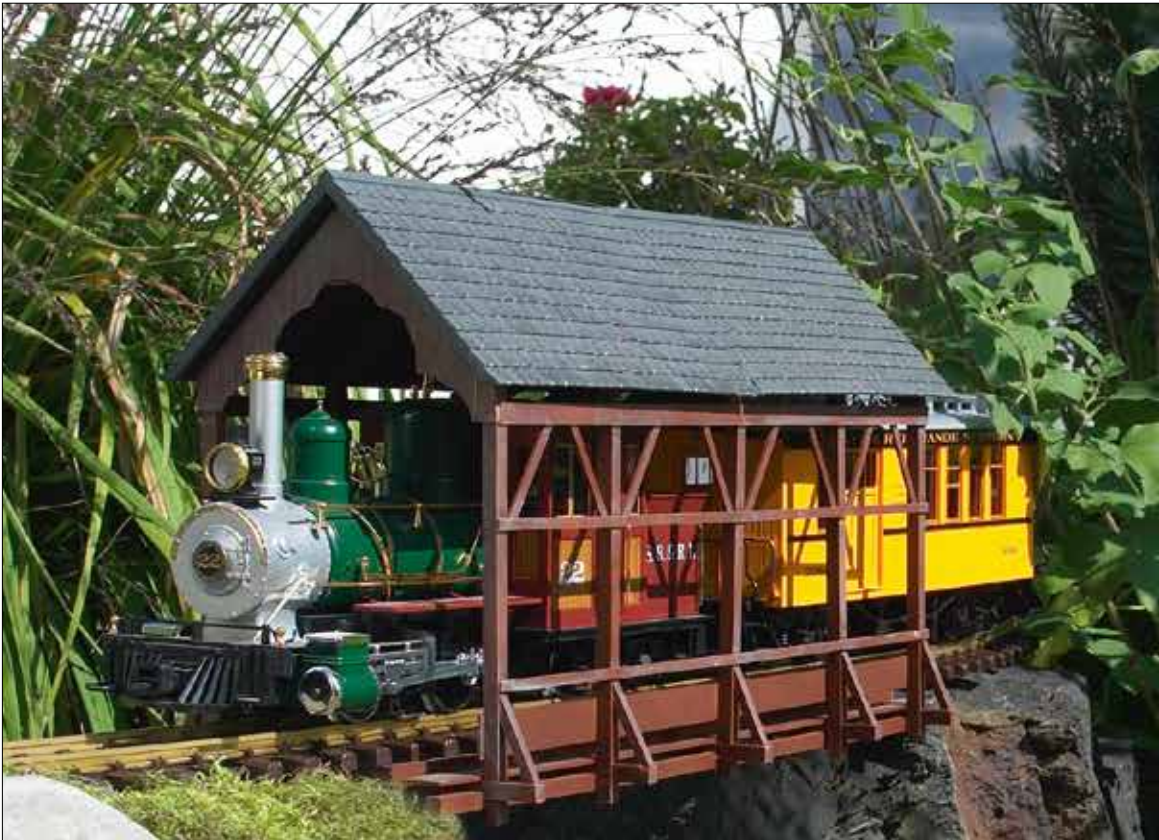

62116 Covered Bridge

The classic covered bridge is a well-known symbol of days gone by in America. This PIKO model captures all the charm of the original. The bridge deck is ready for easy installation of your track.
Note: Check vertical clearance of rolling stock before assembling the bridge. Bridge has limited overhead clearance and the decorative end panels can be left off to provide extra clearance.

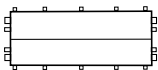

520 x 210 x 290 mm
 21.2 x 8.6 x 11.8 "

Kiosk
 150 x 150 x 170 mm
 5.9 x 5.9 x 6.7 "

Teepee
 190 x 190 x 300 mm
 7.7 x 7.7 x 12.2 "

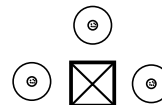

62111 Trading Post

The trading post and three teepees form quite a tourist attraction. Locally made jewelry and souvenirs are offered here. The door can be opened and closed. Teepees pictured below





62104 Dr. Reynolds Country Home

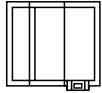

280 x 260 x 230 mm
11.0 x 10.2 x 9.1 "

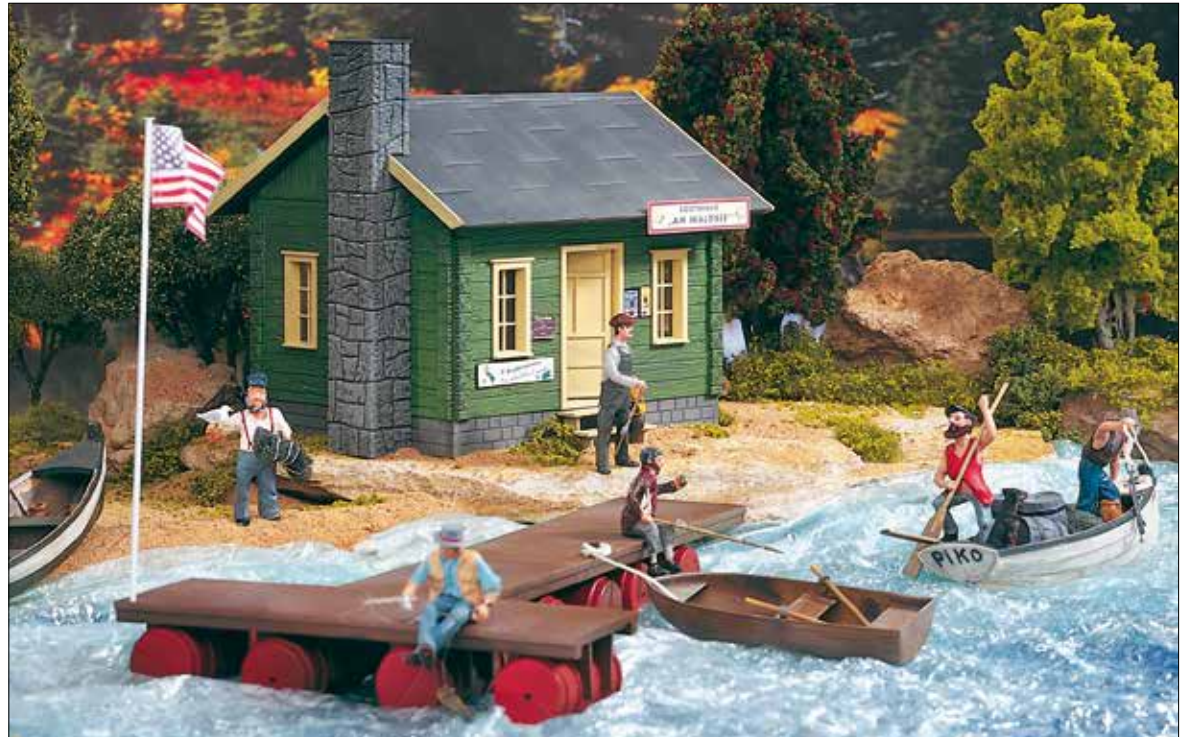

62103 Bait & Tackle Shop

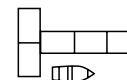

House:
254 x 230 x 230 mm
10.0 x 9.1 x 9.1 "



Pontoon Dock:
400 x 220 x 45 mm
15.7 x 8.7 x 1.8 "

62283 Rowing Boat

The little boat is a perfect addition to the "Bait & Tackle Shop" kit #62103. Color may vary from photo.



62012 Gazebo

The gazebo's roof is supported by 12 columns. Flower-pots and flower material for the pots are included. The gazebo is weather-resistant and is a great attraction on any layout.



270 x 270 x 250 mm
10.6 x 10.6 x 9.8 "



62242 Fire-Department No. 6

The fire station can often be found near the railroad station. With two large moveable doors, windows with gratings and the sturdy stone surfacing, the building provides sufficient space for the firefighters and the fire engine.

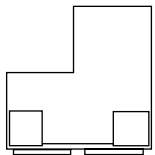

420 x 390 x 310 mm
16.5 x 15.4 x 12.2 "



62251 Filling Station

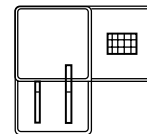

420 x 390 x 310 mm
16.5 x 15.4 x 12.2 "



62120 White Barn

Once a common sight along American highways and byways, barns – and their roofs – were used to advertise many things, such as fireworks for sale at the next exit.

The doors of the barn open. The kit includes two different style roofs and signs in English as well as in German.

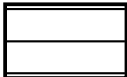

260 x 400 x 280 mm
10.2 x 15.7 x 11.0 "



62110 Red Barn



400 x 400 x 280 mm
15.7 x 15.7 x 11.0 "

62291 White Wooden Fence

The white wooden fence is 63 " (160 cm) long. It can be arranged in a straight line or around a yard with 90° corners.





Original Layout: Ron Gibson

62222 Fire Post

Lookouts like this are used throughout North America to monitor forests for wildfires. The observation platform sits atop a finely detailed timber frame with integrated wooden staircase. The Fire Post is weather-resistant and realistically aged.



220 x 220 x 720 mm
8.7 x 8.7 x 28.3 "



62112 Old Fallsington Feed and Seed Company

Henry Fallsington prefers to take life easy, sitting back in his rocking chair rather than loading railroad cars spotted at the elevated platform or working in the office of his little warehouse. (Rocking chair #62295 not included) The door of this aged model can be opened and closed.

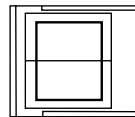

Platform:
340 x 285 x 225/170/125 mm
13.9 x 11.6 x 9.2/6.9/5.1 "
Building:
240 x 230 x 175 mm
9.8 x 9.4 x 7.1 "

62295 Rocking Chairs (Set of 2)

There's nothing like leaning back in a comfortable old rocking chair. Your G-Scale figures will enjoy a relaxing break on a patio or porch. (Figures not included)



62262 Brad's fishing cabin

Brad built his cabin over the lake to be closer to the water. He stores his fishing rods inside the little cabin with opening doors. During weekends he enjoys the peace and quiet.

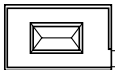

410 x 210 x 180 mm
16.2 x 8.3 x 7.1 "



62054 German Embassy

The German Embassy is situated in an old empire style building with red bricks, slate roof and sand stone window sills. The two opening doors with their small porches, the bay windows and the decorated window sills make the building stand out. The distinctive building fits in no matter what the theme of your layout is. We recommend the baseplates #62005 to enhance the model (1 set).

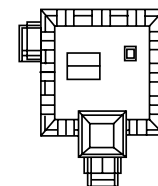

450 x 370 x 505 mm
17.7 x 14.6 x 19.9 "

62223 "Black Hill" Saloon

With the functional swing door and large balcony, that stretches across the entire front, the building is a typical US-Western-Saloon. The weather-resistant building has been realistically weathered.



400 x 300 x 360 mm
15.7 x 11.8 x 14.2 "



62224 Pony Express Cabin

①

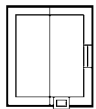

254 x 230 x 230 mm
10.0 x 9.1 x 9.1 "

62225 City Sheriff

②

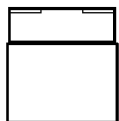

220 x 224 x 210 mm
8.7 x 8.8 x 8.3 "



We recommend the set of baseplates #62005 to enhance the model (1 set).



62246 Outhouse

This kit is a realistic model of a typical outhouse, once a quite common necessity! The door with the customary heart shaped window opens.

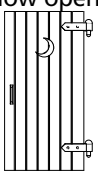

The kit includes a second door with a half moon window for the US.



60 x 70 x 110 mm
2.4 x 2.8 x 4.3 "



62247 Stable

The small ranch stable finds room next to almost any country home. It can easily house a horse or a cow while the back has room to store a small tractor or a car.

We recommend the baseplates #62005 to enhance the model (1 set).

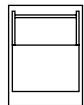

340 x 250 x 135 mm
13.4 x 9.8 x 5.3 "

62229 Country Church

This attractive church with its picturesque little bell tower and porch is an ideal addition to Sam's and Aunt Bea's home. The weather-resistant and slightly weathered model creates a truly American atmosphere. The doors can be opened and closed. We recommend the baseplates #62005 to enhance the model (1 set).

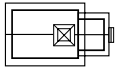

150 x 315 x 360 mm
5.9 x 12.4 x 14.2 "





62221 "Aunt Bea's" Farmhouse



250 x 350 x 315 mm
9.9 x 13.8 x 12.4 "



62249 Cousin Jane's Farmhouse

Typical US-style country home with front porch. The weather-resistant kit is partially aged and has opening doors.

We recommend the set of baseplates #62005 to enhance the model (1 set).



300 x 210 x 235 mm
11.8 x 8.2 x 9.3 "

62248 Grandpa's Farmhouse

This traditional home is built in typical American wood-sided style. Homes like it can be found all across the United States. The doors of the weather-resistant and partially aged model can be opened and closed. We recommend the baseplates #62005 to enhance the model (1 set).



250 x 350 x 315 mm
9.9 x 13.8 x 12.4 "



62226 "Sam's" House



300 x 210 x 235 mm
11.8 x 8.2 x 9.3 "



62208 "Bill's" Body Shop

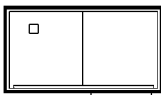

510 x 250 x 260 mm
22.4 x 9.8 x 10.2 "

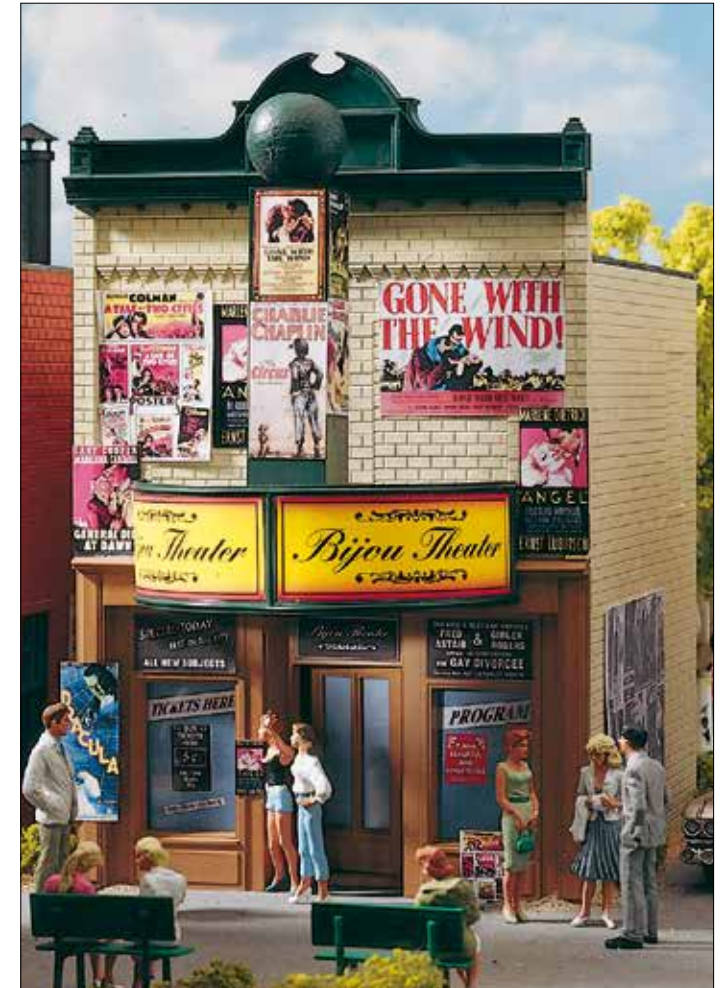

62233 Bijou Theater

Many old movie posters and ads recreate the typical cinema of the thirties. The doors of this weather-resistant and partially aged building can be opened and closed.

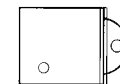

360 x 290 x 345 mm
14.2 x 11.4 x 13.6 "

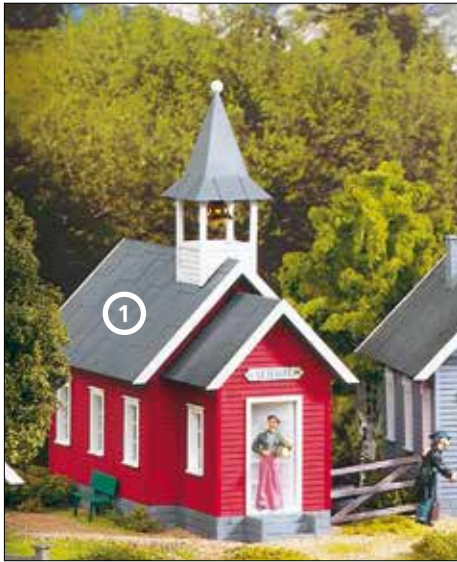

62243 Little Red School House
 ① The attractive little bell tower housing the brass school bell and the strong dark red exterior paint make the building the focal point of any rural garden railroad scene. The door can be opened.

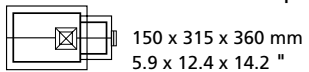

Gingerbread Series



62238 R. King's House (mint green)

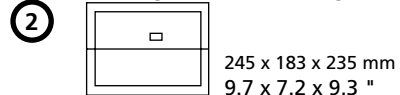

62240 M. Lewis' House (lavender)

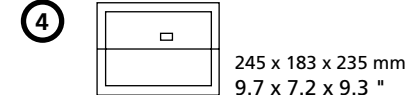

62239 B. Adams' House (yellow)

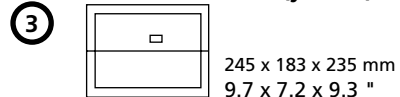

62256 Craft Shop

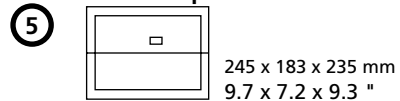



62028 Union Station

The Union Station has platform roofs on each end of the building. A working PIKO clock adorns the front of the building. The station doors open. Benches are included in this kit.

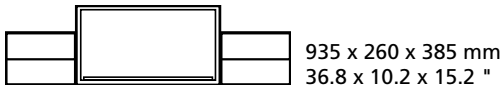

62114 White Knight Hamburgers

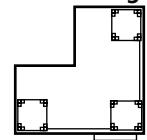

480 x 480 x 355 mm
18.9 x 18.9 x 14.0 "



62078 Mel's Fix-it Shop

Modest but sturdy brick home with attached storage shed for ladders and equipment. The doors of this model can be opened. The scaffolding is included.

We recommend the baseplates #62005 to enhance the model (1 set).

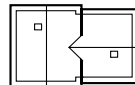

370 x 240 x 240 mm
14.6 x 9.4 x 9.4 "



62259 Peter's Motorcycle Maintenance Shop

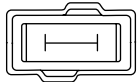

374 x 190 x 225 mm
14.7 x 7.5 x 8.9 "



62258 Dora's Bakery Shop

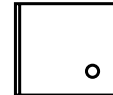

220 x 240 x 305 mm
8.7 x 9.4 x 12.0 "

62257 Farmer's State Bank



220 x 240 x 305 mm
8.7 x 9.4 x 12.0 "

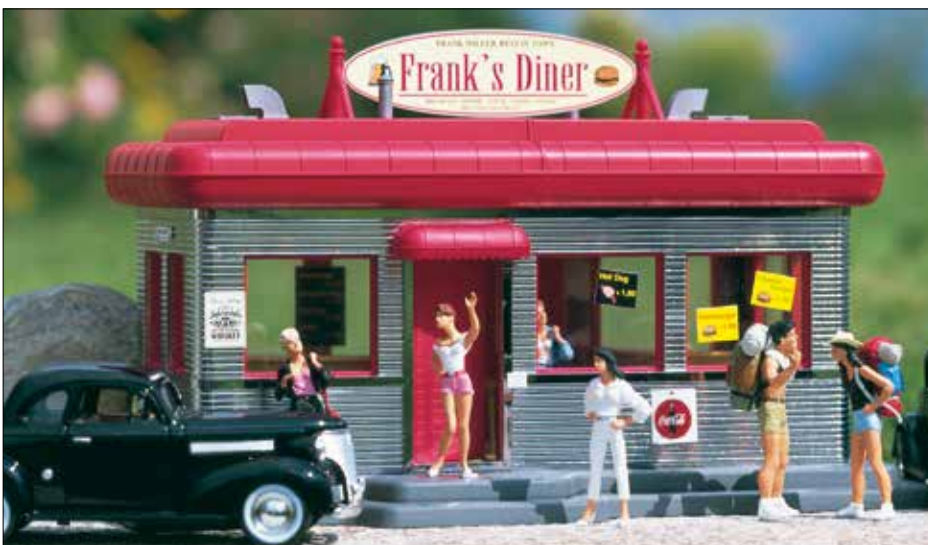

62250 Downtown Diner

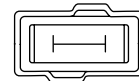

374 x 190 x 225 mm
14.7 x 7.5 x 8.9 "

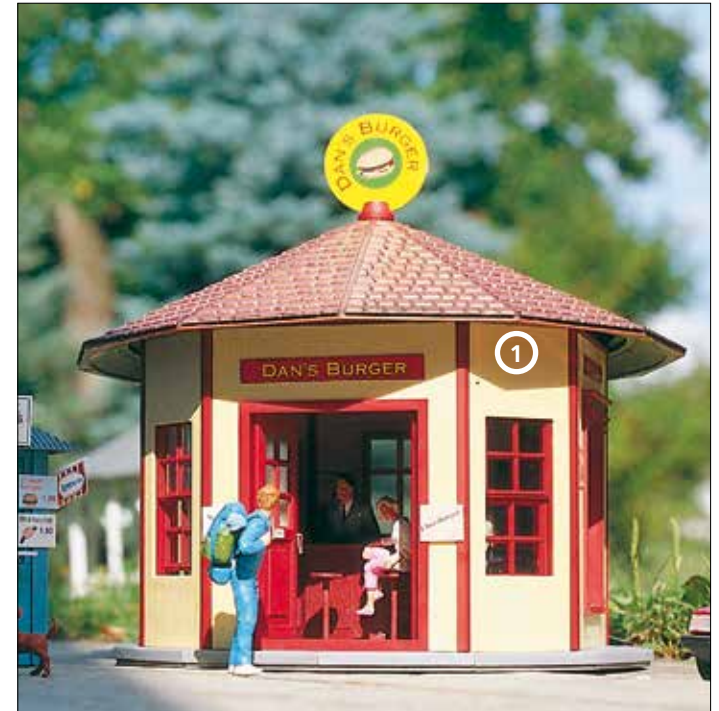

62227 "Dan's" Burger

①



270 x 270 x 253 mm
10.6 x 10.6 x 10.0 "

62266 Michael's Emporium

②



220 x 240 x 460 mm
8.7 x 9.4 x 18.1 "

62267 Hudson's Home Goods

③



220 x 240 x 430 mm
8.7 x 9.4 x 16,9 "



62219 "David's" Barber Shop

④

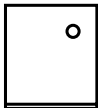

220 x 240 x 305 mm
8.7 x 9.4 x 12.0 "

62204 "Jenny's" Clothing

⑥

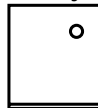

220 x 240 x 345 mm
8.7 x 9.4 x 13.6 "

62220 "Paul's" Dry Goods

⑤

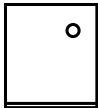

220 x 240 x 305 mm
8.7 x 9.4 x 12.0 "

62207 "Dr. Goldstein's" Pharmacy

⑦

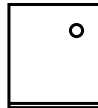

220 x 243 x 330 mm
8.7 x 9.6 x 13.0 "

Buildings such as this two-story brick store were built around the turn of the 20th century and to this day can be found all across North America. The typical sliding windows and the doors open. The kit is weather-resistant and partially aged.

We recommend the set of wooden sidewalks #62281.



62023 The Mansion

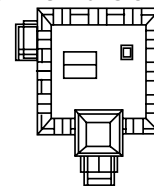

450 x 370 x 505 mm
17.7 x 14.6 x 19.9 "



From an original model designed by Andrew de Lucia, El Dorado Hills, CA

62260 California Hotel

The guests reach the hotel's upper floors via outside stairways that give the building its distinctive look. Built in the architectural style of the early 20th century this hotel is suitable for many types of Western style layouts.

The kit includes base plates.

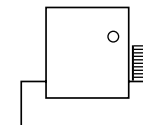

370 x 320 x 450 mm
14.6 x 12.6 x 17.7 "

PLEASANTOWN COLLECTION

The Pleasantown Collection Buildings can be assembled and disassembled easily due to their unique "pin" connector system.

62236 A.C.M.E. Hardware Store

①

62237 Leather Goods & Boots

②

62235 A.C.M.E. Liquor Store

③

62234 General Store

④

62218 Saloon

⑤

62217 Dentist

⑥

62215 White Schoolhouse

⑦

62216 Sheriff's Office

⑧

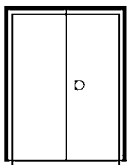

Measurements of all buildings:
141 x 202 x 250 mm
5.6 x 8.0 x 9.8 "





PLEASANTOWN COLLECTION

62214 Fire Station N° 9

9

62213 Post Office

10

62212 Sandy's Candies

11



Qwik Kits!

PLEASANTOWN QWIK-KITS

The Qwik-Kit buildings come partially assembled, to give beautiful results in almost no time.

Windows, doors, signs and details are already installed.

62721 Music Shop

12

62722 Village Furniture

13

62723 Daily Grind Coffee House

14

62724 Book Worm Book Shop

15

Baseplate not included. We recommend the set of baseplates #62005 or the wooden sidewalks #62281 to enhance the model.

BUILT-UP MODELS

PIKO Built-Up models come factory-assembled, with signs installed. In a few instances, certain parts may require simple final assembly, for safe transport in the package.



62707 Hill's Gingerbread House, Built-Up

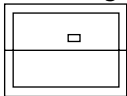

245 x 183 x 235 mm
9.7 x 7.2 x 9.3 "

62708 Washburn's Gingerbread House, Built-Up

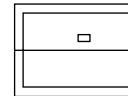

245 x 183 x 235 mm
9.7 x 7.2 x 9.3 "



62718 Railroad Tool Shed 2-Pack, Built-Up

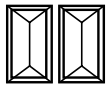

90 x 160 x 130 mm
3.5 x 6.3 x 5.1 "



62719 Outhouse 2-Pack, Built-Up



60 x 70 x 110 mm
2.4 x 2.8 x 4.3 "



Figures and accessories not included.

62725 Joe's Shoe Repair, Built-Up



240 x 230 x 200 mm
9.5 x 9.0 x 7.9 "

BUILT-UP MODELS

PIKO Built-Up models come factory-assembled, with signs installed. In a few instances, certain parts may require simple final assembly, for safe transport in the package.

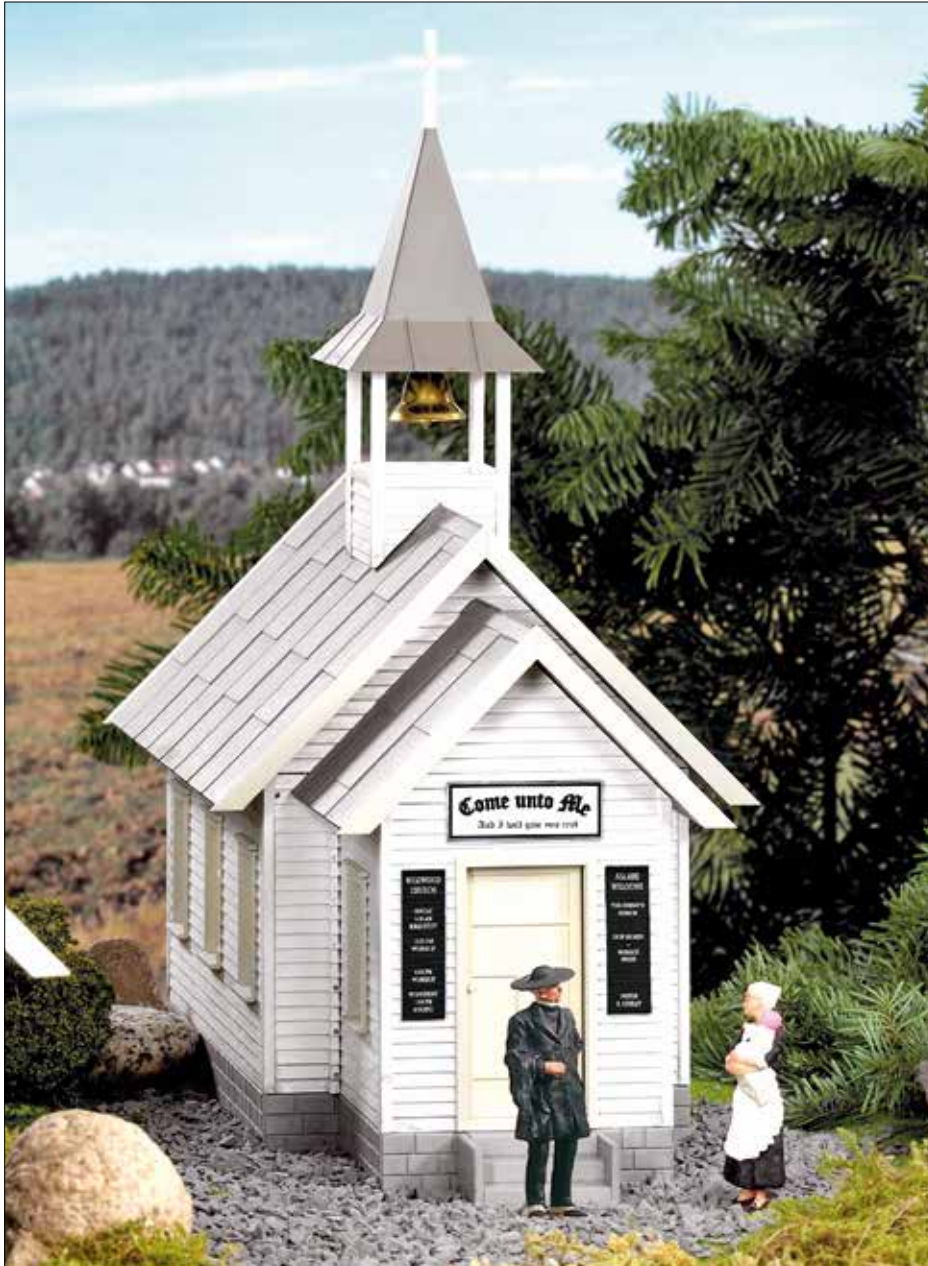

62726 River City, Buffalo Bill's Barber Shop, Built-Up



141 x 202 x 240 mm
5.6 x 8.0 x 9.5 "

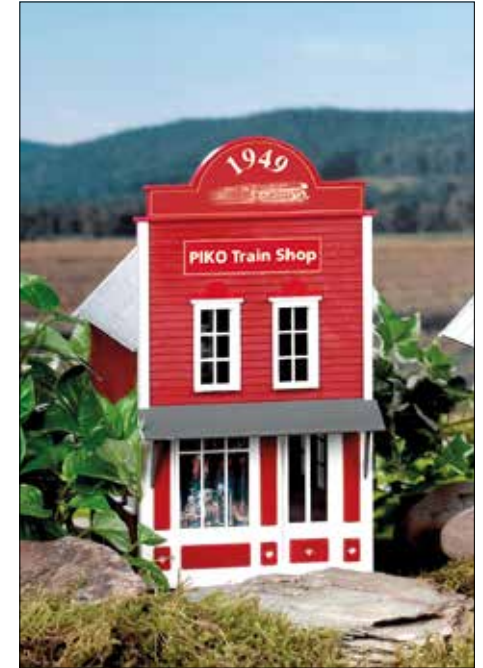

62705 PIKO Train Shop, Built-Up

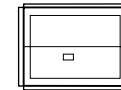

141 x 202 x 250 mm
5.6 x 8.0 x 9.8 "

62706 Wildwood Church, Built-Up

This attractive church with its picturesque little bell tower and porch is an ideal addition to any layout. The weather-resistant and slightly weathered model creates a truly American atmosphere. The doors can be opened and closed.

We recommend the baseplates #62005 to enhance the model (1 set).

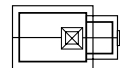

150 x 315 x 360 mm
5.9 x 12.4 x 14.2 "



62716 River City Tommy's Cabin, Built-Up

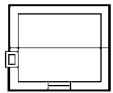

254 x 230 x 230 mm
10.0 x 9.1 x 9.1 "



62700 Green River Station, Built-Up

①

The station comes pre-assembled. It can be disassembled easily and is weather-resistant as well as partially aged. The doors open.

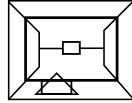

215 x 175 x 205 mm
8.5 x 6.9 x 8.1 "

62701 Old West Water Tower, Built-Up

②

Built-Up model. The tank can be filled with water and emptied via the spout.



170 x 170 x 270 mm
6.7 x 6.7 x 10.6 "

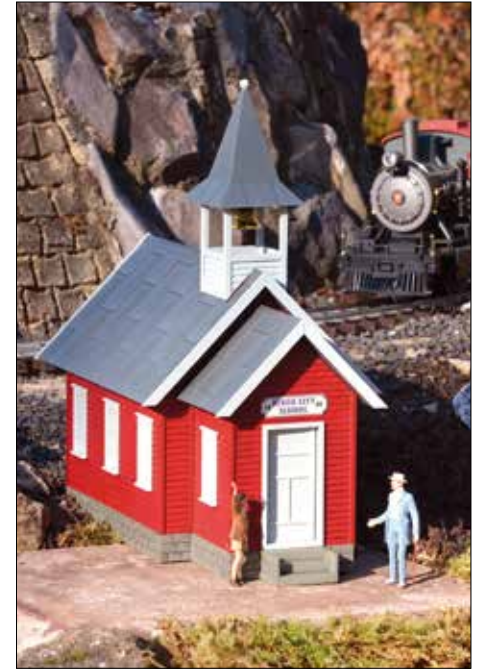

62717 River City School House, Built-Up

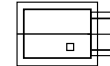

150 x 315 x 250 mm
5.9 x 12.4 x 9.8 "

PIKO Built-Up models come factory-assembled, with signs installed. In a few instances, certain parts may require simple final assembly, for safe transport in the package.



62714 River City Squires' Livery, Built-Up

①

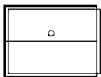

141 x 202 x 250 mm
5.6 x 8.0 x 9.8 "

62715 River City Shinn's Billiard Parlor, Built-Up

②

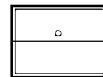

141 x 202 x 250 mm
5.6 x 8.0 x 9.8 "

62709 River City Station, Built-Up

③

The station comes pre-assembled. It can be disassembled easily and is weather-resistant as well as partially aged. The doors open.

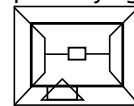

215 x 175 x 205 mm
8.5 x 6.9 x 8.1 "

62710 River City Water Tower, Built-Up

④

Built-Up model. The tank can be filled with water and emptied via the spout.

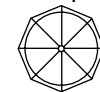

170 x 170 x 270 mm
6.7 x 6.7 x 10.6 "



62265 North Pole Station, Built-Up

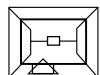

215 x 175 x 205 mm
8.5 x 6.9 x 8.1 "

62702 North Pole Water Tank, Built-Up



170 x 170 x 270 mm
6.7 x 6.7 x 10.6 "



62703 Santa's House, Built-Up



183 x 245 x 235 mm
7.2 x 9.7 x 9.3 "



62814 Set of Icicles

2 pcs. 282 x 39 mm
2 pcs. 207 x 30 mm
8 pcs. 62 x 36 mm



62268 ChristmasTown Station, Building Kit

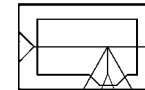

485 x 310 x 290 mm
19.1 x 12.2 x 11.4 "



62269 ChristmasTown Ornament Factory, Building Kit

①

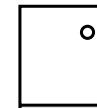

220 x 240 x 305 mm
8.7 x 9.4 x 12.0 "

62268 ChristmasTown Candle Shoppe, Building Kit

②



220 x 243 x 330 mm
8.7 x 9.6 x 13.0 "



The Pleasantown Collection Buildings can be assembled and disassembled easily due to their unique "pin" connector system.

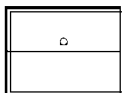

Measurements of all buildings:
141 x 202 x 250 mm
approx. 5.6 x 8.0 x 9.8 "

62200 Santa's Work Shop

①

62201 Robin's Toy Shop

②

62202 The Village Inn

③

62203 St. Thomas Church

④

A brass bell is included.

62800 - 62813 G Construction elements

In order to provide creative G scale enthusiasts with the means of kitbashing their own imaginative designs, PIKO offers the a variety of individual building parts.

62800	Doors	2 x A	218 x 206 mm	8.6 x 8.1 "
		2 x B	45 x 110 mm	1.8 x 4.3 "
		2 x C	76 x 101 mm	3.0 x 4.0 "
62801	Metal Roof	4 x	224 x 240 mm	8.8 x 9.5 "
62802	Shingle Roof	2 x	475 x 198 mm	18.7 x 7.8 "

62801 Metal Roofs



62802 Shingle Roof



62800 Doors

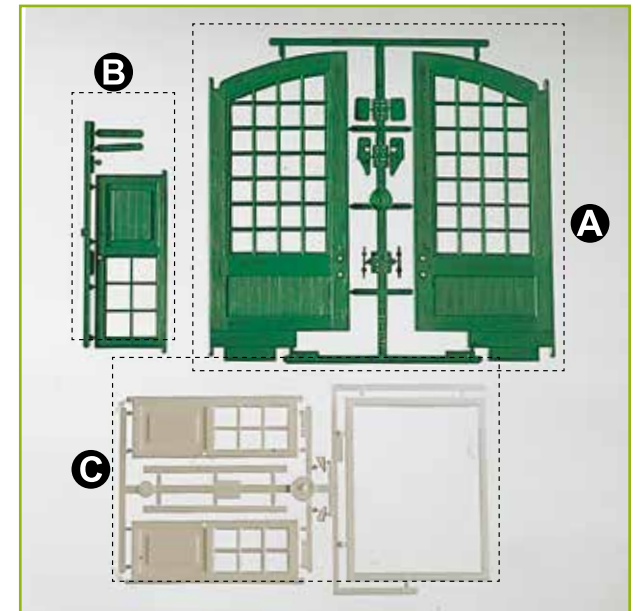

62803 Tiled Roofs

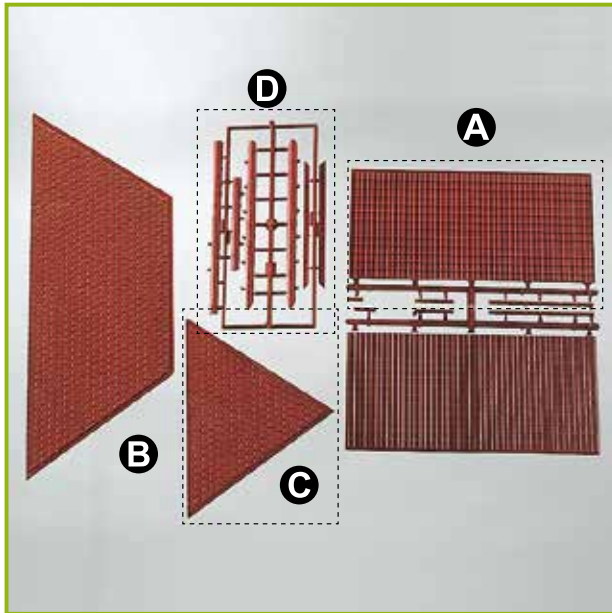

62803	Tiled Roofs	2 x A 2 x B 2 x C 2 x D	287 x 137 mm 455 x 172 mm 235 x 172 mm	11.3 x 5.4 " 17.9 x 6.8 " 9.3 x 6.8 "
62804	Windows of Brewery	3 x A 3 x B 3 x C 3 x D 3 x E 6 x F	44 x 96 mm 60 x 96 mm 44 x 96 mm 60 x 96 mm 95 x 27 mm Ø 26 mm	1.7 x 3.8 " 2.4 x 3.8 " 1.7 x 3.8 " 2.4 x 3.8 " 3.8 x 1.0 " Ø 1.0 "
62805	Windows and Shutters	6 x A 4 x B 4 x C 6 x D 2 x E 8 x F	19 x 49 mm 22 x 76 mm 48 x 82 mm 35 x 48 mm Ø 21 mm 36 x 7 x 7 mm	0.8 x 1.9 " 0.9 x 3.0 " 1.9 x 3.2 " 35 x 48 " Ø 0.8 " 1.4 x 0.3 x 0.3 "
62806	Sliding Windows and Door	2 x A 4 x B 8 x C	42 x 98 mm 38 x 50 mm 38 x 38 mm	1.7 x 3.9 " 1.5 x 2.0 " 1.5 x 1.5 "

62804 Windows of Brewery

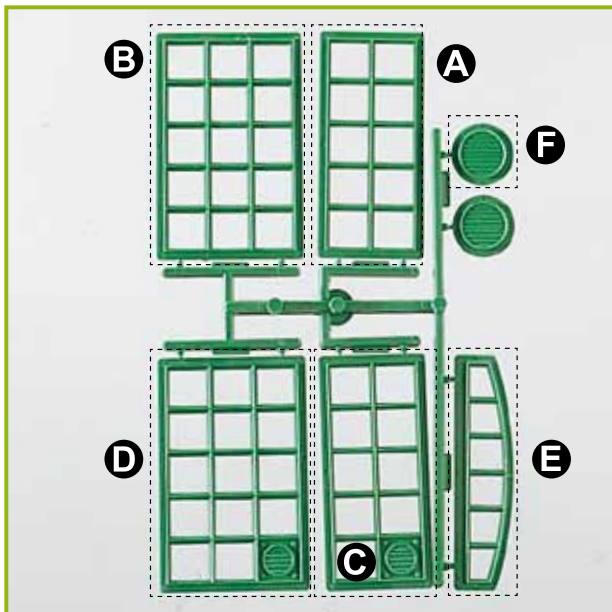

62805 Windows and Shutters

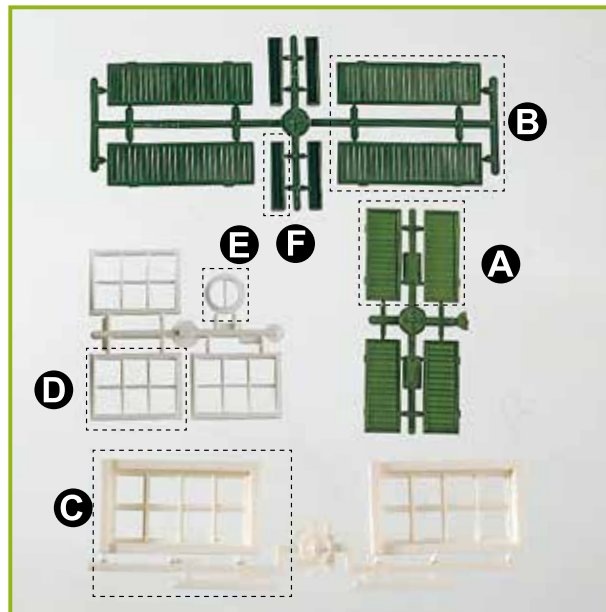

62806 Sliding Windows and Door

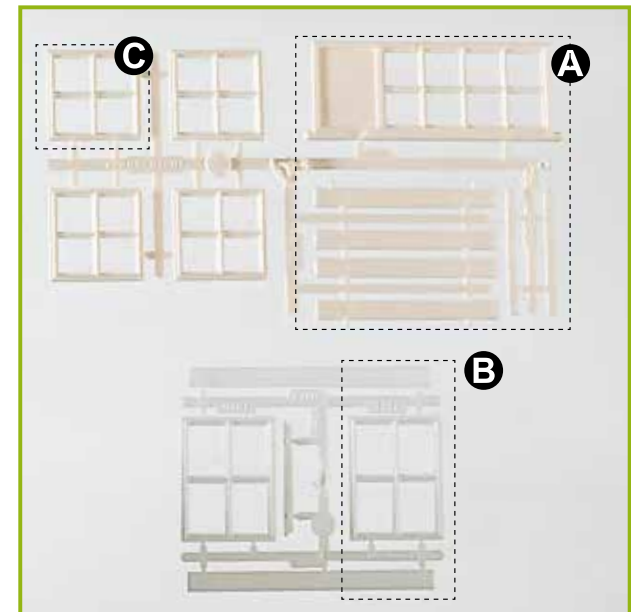

62807 Round Arch Windows

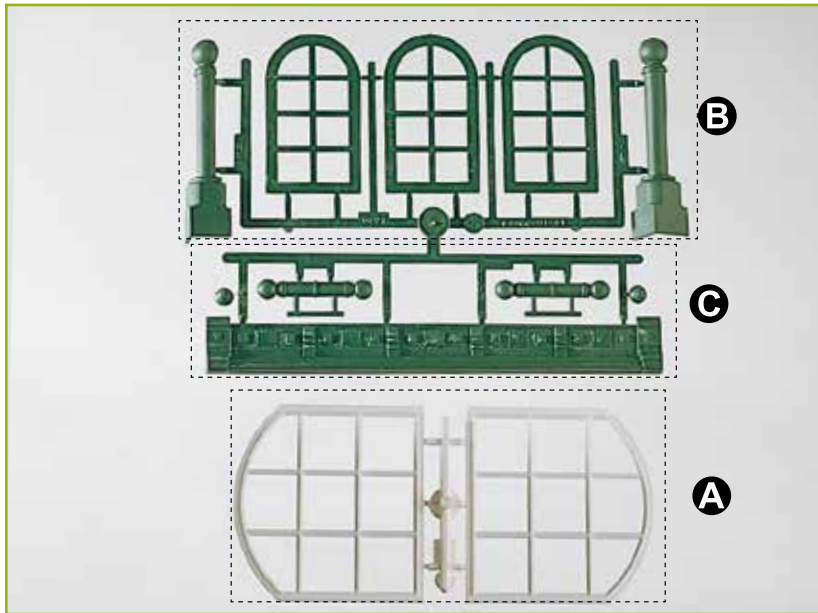

62807	Round Arch Windows	2 x A 1 x B 1 x C	94,5 x 90 mm 46 x 80 mm 218 x 28 mm	3.7 x 3.5 " 1.8 x 3.2 " 8.6 x 1.1 "
62808	Corners of Brewery	4 x A 4 x B 4 x C	5 x 193 mm 20 x 193 mm 20 x 20 x 193 mm	0.2 x 7.6 " 0.8 x 7.6 " 0.8 x 0.8 x 7.6 " including little parts
62809	US Brick Walls	2 x A 1 x B 1 x C	233 x 258 mm 218 x 258 mm 218 x 160 mm	9.2 x 10.2 " 8.6 x 10.2 " 8.6 x 6.3 "
62810	Wooden Walls	2 x A 2 x B	233 x 258 mm 149 x 258 mm	9.2 x 10.2 " 5.6 x 10.2 "

62808 Corners of Brewery

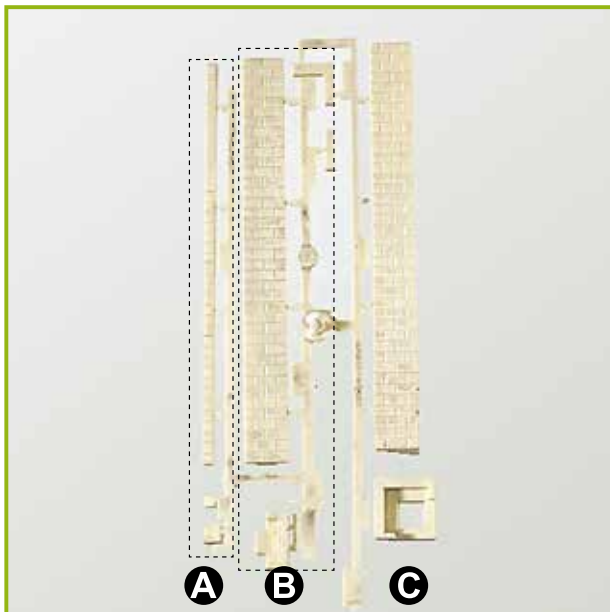

62809 US Brick Walls

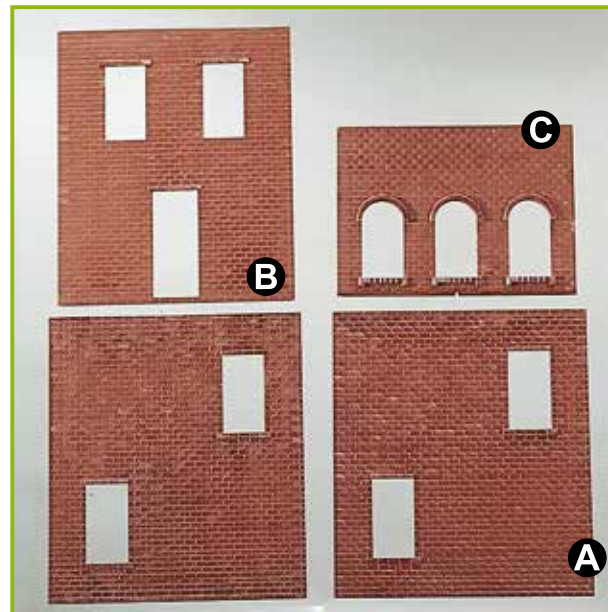

62810 Wooden Walls

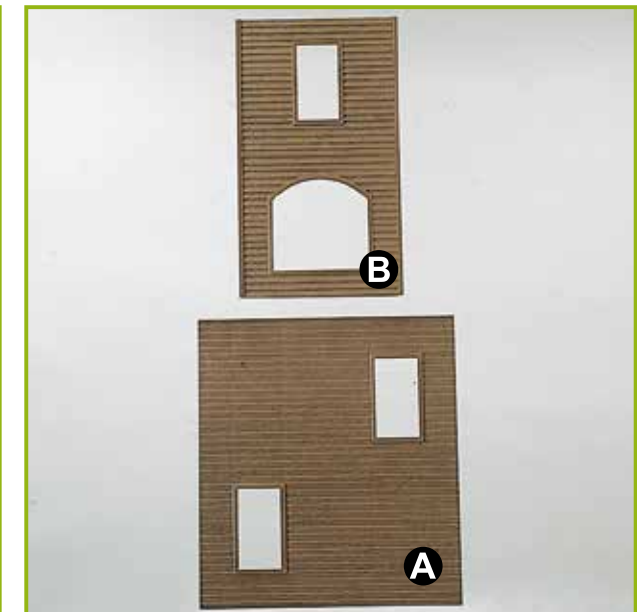

62811 Brewery Walls

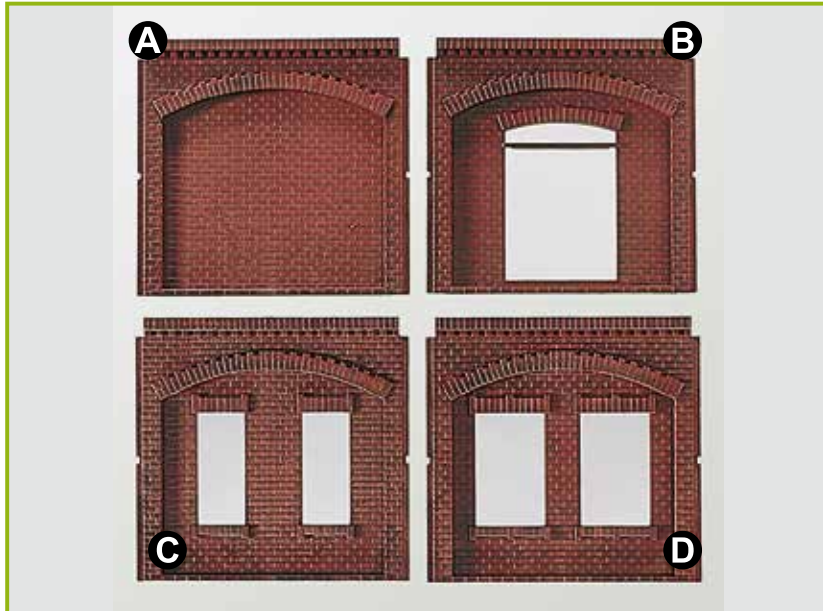

62811	Brewery Walls	1 x A 1 x B 1 x C 1 x D	219 x 209 mm 219 x 209 mm 219 x 209 mm 219 x 209 mm	8.6 x 8.2 " 8.6 x 8.2 " 8.6 x 8.2 " 8.6 x 8.2 "
62812	Chimneys Assortment	2 x A 2 x B 2 x C		
62813	Window Glass	4 x A 4 x B 12 x C 2 x D 2 x E	61 x 95 mm 35 x 80 mm 33 x 33 mm 52 x 32 mm 96 x 28 mm	2.4 x 3.7 " 1.4 x 3.1 " 1.3 x 1.3 " 2.0 x 1.3 " 3.8 x 1.1 "

62813 Window Glasses

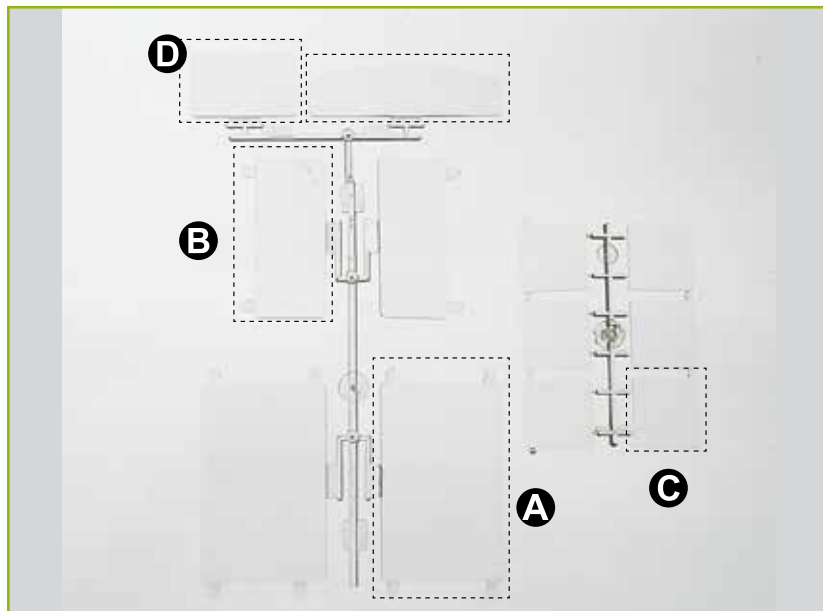

62812 Assorted Chimneys

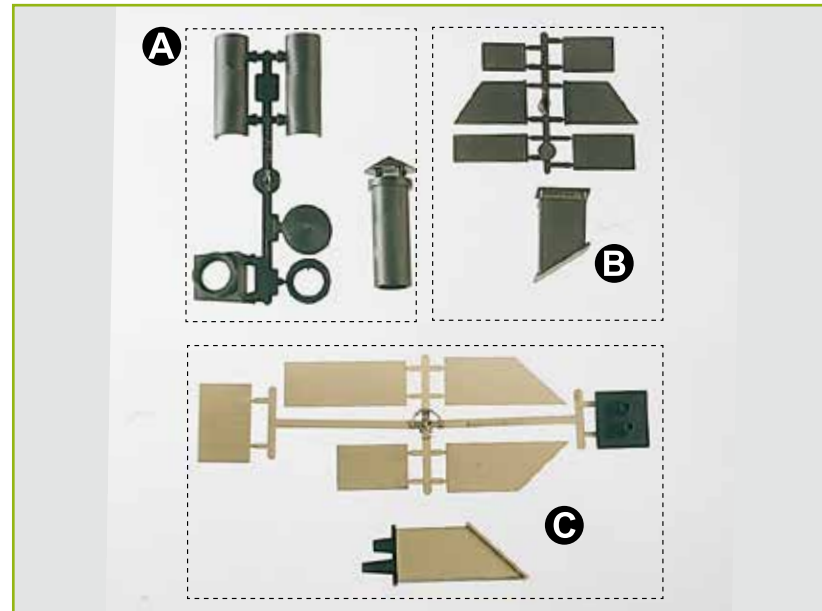

62280 Split Rail Fence

Fences made of split timbers are typical on North American farms. Eight sections with a total length of approximately 63 ".



55701 PIKO-Fix Plastic Model Cement
Needle-point dispenser for precise application. Strong solvent-type plastic model cement. Recommended for assembling all PIKO buildings, especially buildings for outdoor use.



62281 Wooden Sidewalks
Classic wooden sidewalks. An ideal addition to your Western town.



62091 House Light

The finely detailed model is fully operational, weather-resistant, made partly out of brass and can be fitted easily to any building. Height: 2.5 "



62090 Street Lamp

Operating, weather-resistant street lamp with brass lamp post. Height: 13.4 "



62297 US Mail Box
Parts for 4 mailboxes included in Kit.



55757 Lights

4 Light Sockets with light bulbs 16 V, E 5,5 for use as indoor lighting in all G- and 1 Gauge buildings.



55758 Light Bulbs

10 pc. Light Bulbs 16 V for use in Interior Lights #55757.

Item #	Page	Item #	Page	Item #	Page	Item #	Page	Item #	Page	Item #	Page	Item #	Page	Item #	Page
38511	37	38774	94	38939	87	62008	126	62057	147	62208	162	62248	161	62296	129
38512	37	38775	86	38940	87	62009	143	62058	149	62209	130	62249	161	62297	184
38513	37	38778	94	38941	91	62009	143	62059	134	62210	130	62250	165	62297	184
38514	37	38779	95	38942	91	62010	143	62064	146	62212	171	62251	154	62700	175
38515	36	38784	95	38943	91	62011	143	62065	146	62213	171	62252	136	62701	175
38600	68	38785	95	38945	96	62012	153	62066	146	62214	171	62253	136	62702	178
38601	68	38786	92	38946	97	62013	139	62067	146	62215	170	62254	136	62703	178
38602	68	38788	92	38947	97	62014	138	62068	146	62216	170	62256	163	62705	174
38603	68	38789	92	38948	97	62015	139	62072	149	62217	170	62257	165	62706	174
38610	68	38790	96	38950	85	62016	139	62073	149	62218	170	62258	165	62707	172
38626	71	38791	93	38951	85	62017	139	62077	133	62219	167	62259	165	62708	172
38628	71	38792	86	38952	84	62018	142	62078	164	62220	167	62260	169	62709	177
38645	74	38795	93	38953	85	62019	142	62090	184	62221	161	62261	133	62710	176
38647	74	38796	86	38954	88	62021	135	62091	184	62222	156	62262	157	62714	177
38650	70	38809	90	38955	88	62022	148	62103	153	62223	158	62264	151	62715	176
38651	70	38825	90	38956	87	62023	168	62104	153	62224	158	62265	178	62716	175
38652	70	38831	90	38959	89	62028	164	62105	137	62225	158	62266	166	62717	175
38653	73	38885	90	38960	89	62030	127	62106	137	62226	161	62267	166	62718	173
38654	73	38903	87	38962	92	62032	128	62108	137	62227	166	62268	178	62719	173
38655	73	38909	87	38963	92	62034	144	62109	134	62228	134	62269	178	62721	171
38656	73	38910	87	38964	88	62035	144	62110	155	62229	160	62280	184	62722	171
38657	69	38913	85	38965	90	62036	145	62111	152	62230	131	62281	184	62723	171
38658	69	38915	85	38969	97	62037	140	62112	156	62231	131	62282	148	62724	171
38659	69	38918	89	55701	184	62038	140	62113	129	62232	129	62283	153	62725	173
38660	69	38921	87	55701	184	62039	140	62114	164	62233	162	62284	151	62726	176
38661	74	38922	91	55757	184	62044	133	62116	152	62234	170	62285	135	62800	180
38662	74	38923	91	55757	184	62046	141	62117	150	62235	170	62286	151	62801	180
38663	71	38924	88	55758	184	62047	141	62118	150	62236	170	62287	145	62802	180
38664	71	38925	87	55758	184	62048	141	62119	150	62237	170	62288	139	62803	181
38665	71	38926	90	56301	121	62049	141	62120	155	62238	163	62289	139	62804	181
38666	71	38928	87	56415	114	62050	147	62200	179	62239	163	62290	140	62805	181
38667	72	38930	89	56416	114	62051	148	62201	179	62240	163	62291	155	62806	181
38668	72	38931	84	62001	132	62052	148	62202	179	62242	154	62293	151	62807	182
38732	93	38933	84	62002	132	62053	147	62203	179	62243	163	62294	151	62808	182
38754	93	38934	89	62006	127	62054	190	62204	167	62246	159	62295	156	62809	182
38773	94	38938	87	62007	132	62056	133	62207	167	62247	159	62296	129	62810	182
														62811	183
														62812	183
														62813	183
														62814	178

CELEBRATING 75 YEARS

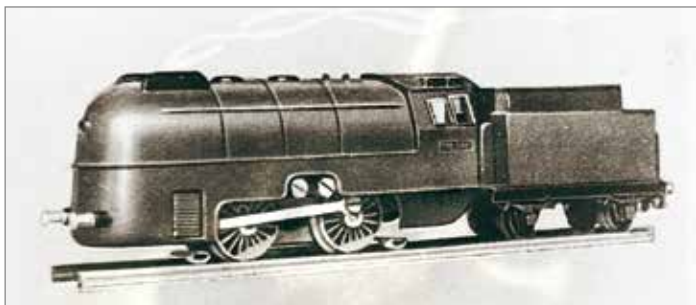

In 2024, it will be 75 years since the first Pico Express (yes, back then PIKO was spelled with a "c") made its rounds at the Leipzig Autumn Product Fair. Time to pause for a moment and take a quick look back.

Since 1952, production has been based in the historic toymaking town of Sonneberg, in the German state of Thüringen. So, it should come as no surprise that PIKO is deeply rooted in the region. Over the years, VEB PIKO (PIKO was a Volkseigener Betrieb, literally "People-owned Company", the East German government way of saying it was state-owned) first became the flagship company of the PIKO Spielwaren combine, which also made a wide variety of other toy products over the decades, and later the product group lead company for model trains. The combine was dissolved following German reunification in 1990. Fortunately, the planned liquidation of the company was prevented when Dr. René F. Wilfer took over the company in May, 1992. Since then, PIKO Spielwaren GmbH has developed continuously and sustainably and is now one of the world's leading manufacturers of high-quality model trains and accessories. In 2024, we can look back on 75 years full of great PIKO model trains, buildings and accessories... and unforgettable memories!

Of course, none of this would be possible without you, our customers—and that is why we want to thank you from the bottom of our hearts for your support. We hope that you will continue to enjoy model railroading with PIKO in the future and that you will create many more wonderful memories with us. We are already looking forward to it!

Photos, clockwise from left center: The first Pico Express from 1949; A pair of PIKO HO electric locos; The early PIKO factory in Leipzig; A modern-day view, showing historic PIKO signage; The PIKO factory in Sonneberg, prior to modernization.





Another first, only from PIKO! 25-Ton diesel locos factory-equipped for full battery-powered operation, with PIKO R/C and realistic digital sound built-in. Run the train over any track, ring the bell, blow the horn—all controlled from the easy and convenient Pocket Remote included with the loco. See page 37 for more details.



Our 38113 UP Freight Starter Set comes complete with an 0-6-0T steam loco, two freight cars, a circle of PIKO G-Track, and a safety-approved 120 volt transformer with a precision analog DC throttle. See page 11



Our new 38237 D&RGW Mogul #223 features great-working smoke, directional lights, and a fantastic digital sound system, with extensive features on Analog DC as well as DCC operation. See page 39



PIKO Spielwaren GmbH | Lutherstraße 30 | 96515 Sonneberg, Germany
 Tel. +49 (3675) 8972 - 42 | Fax +49 (3675) 8972 - 50 | hotline@piko.de
 www.piko.de PIKO® ist ein eingetragenes Warenzeichen.



PIKO America LLC | 4610 Alvarado Canyon Rd., Suite 5 | San Diego CA 92120
 Phone 619-280-2800 | Toll-Free 877-678-4449 | support@piko-america.com

www.piko-america.com

PIKO® is a registered Trademark. All rights reserved.

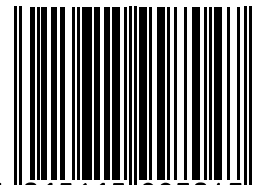

4 015615 997047

99704US 2023 © PIKO Spielwaren GmbH